

富士电机 功率半导体

IGBT/SiC 器件选型手册



CONTENTS

Small IPM	11	Standard 2-Pack	21	Hybrid SiC Modules	28
IPM	12	Standard 1-Pack / Chopper	23	All-SiC Modules	29
Small PIM	16	HPnC	24	Discrete IGBT	30
PIM	17	PrimePACK™	25	SiC-SBD	31
6-Pack	19	T/I-type NPC 3-level	27	注：PrimePACK™为 Infineon Technologies 公司的注册商标。	

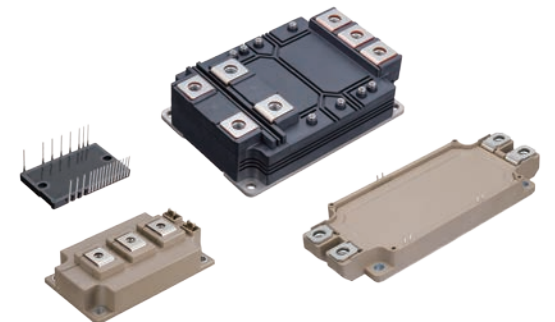

IGBT模块 X系列的优点

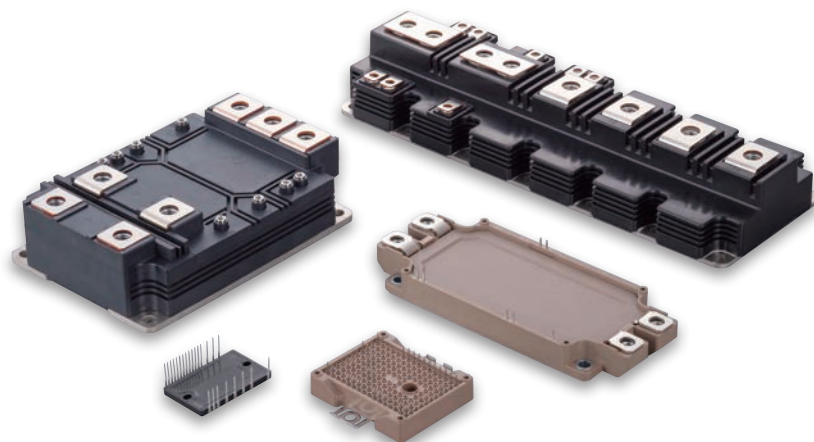

1. 低损耗

通过减小模块内部 IGBT 及二极管芯片的厚度实现微细化，从而优化了模块结构。

因此，与以往产品相比（本公司第 6 代“V 系列”），降低变频器运行时的电力损耗。

变频器损耗降低 10%，芯片温度降低 11°C
(与第 6 代 V 系列 75A, $f_c=8\text{kHz}$ 相比)

变频器损耗比较 (标准例)

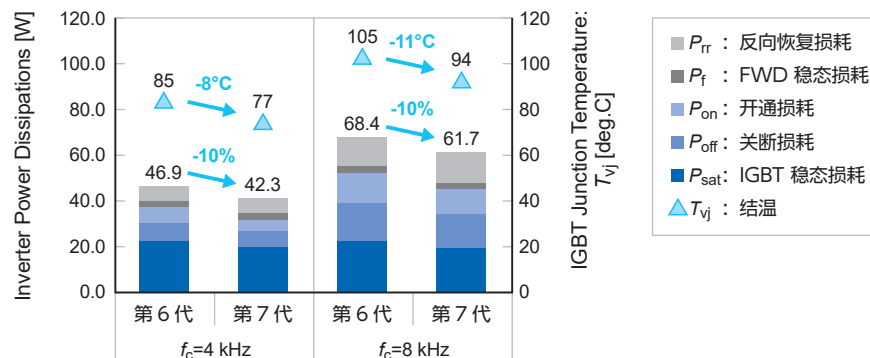

2. 小型化

运用新开发的绝缘板，提高模块的散热性能。通过在减少电力损耗的同时抑制发热，一部分产品的大小可以比以往同规格产品缩小约 36%。

适用例)

36% 小型化

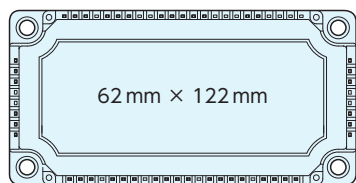

1200V 75A (第 6 代 V 系列)

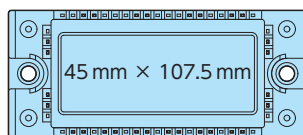

1200V 75A (第 7 代 X 系列)

3. 高温动作

高可靠性高耐热的封装，加上优化的芯片，实现了 175°C 连续动作。

- 与以往产品相比可进一步提高 35% 的输出
- ΔT_{vj} 功率寿命循环是以往产品的 2 倍，即使在 175°C 连续工况下也能保证同等寿命

通过实现 $T_{vj(op)}=175^\circ\text{C}$ ，进一步提高了输出

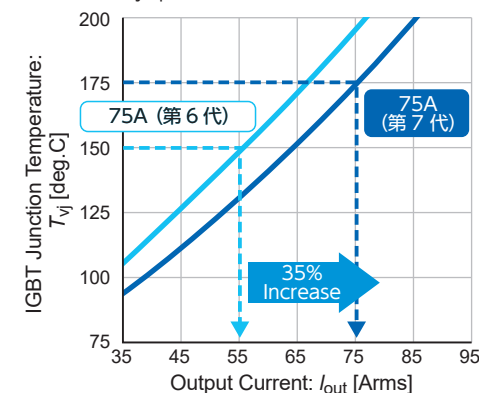

Product Map

我们提供各种功率半导体产品，可实现低损耗、高效率的电力转换，适用于各种电力容量应用，包括工业机械、社会基础设施、可再生能源、家用电器和信息设备。

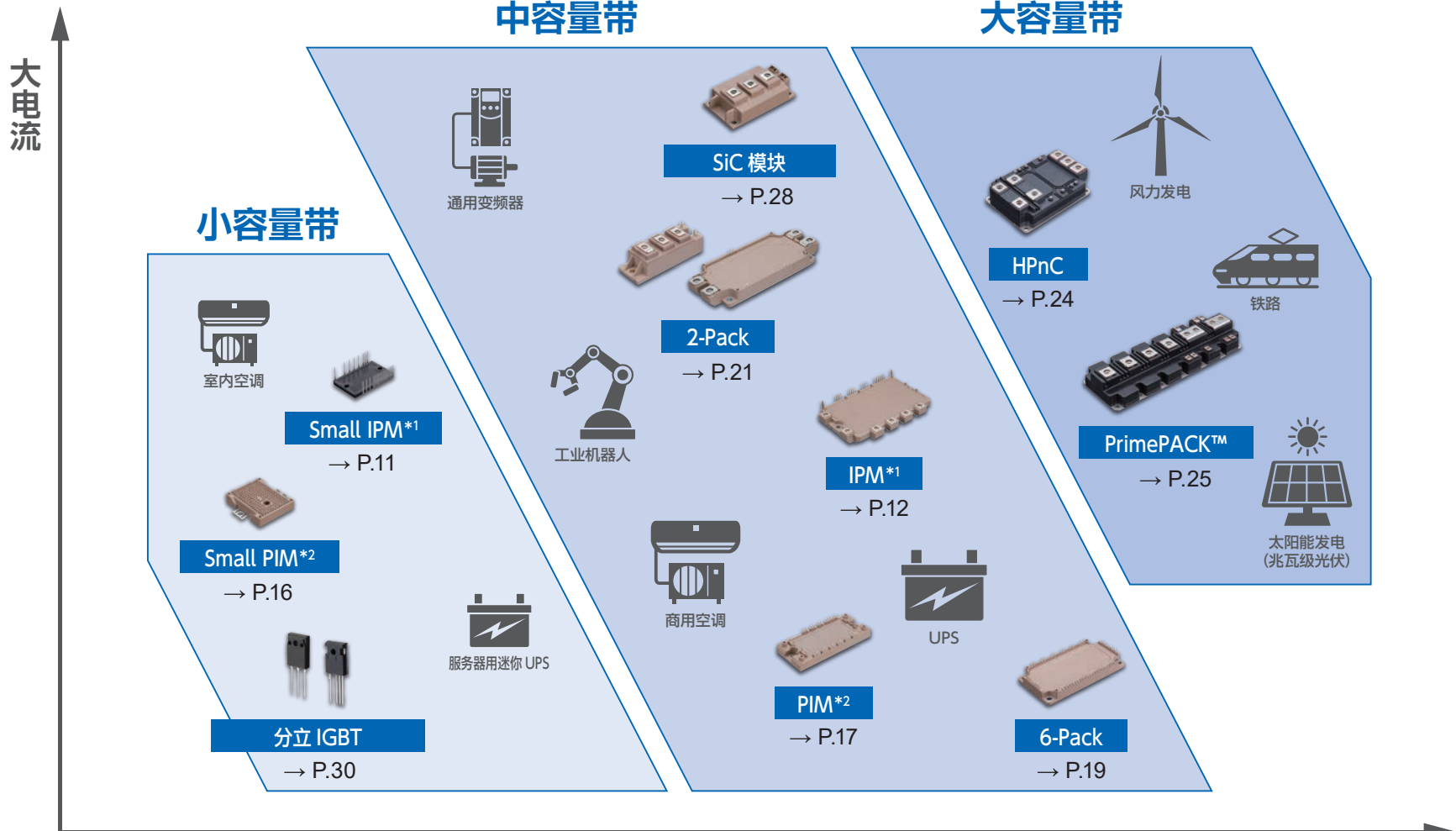

注: PrimePACK™为 Infineon Technologies 公司的注册商标。

*1 Intelligent Power Module

*2 Power Integrated Module

高耐压

开关数	产品种类	页次	内部结构					上限电压 Max V _{CE} (V _{RRM})						额定电流						
			功率模块				Discrete IGBT	Discrete SiC-SBD	600V	650V	1200V	1700V	2300V	3300V	≤50A	>50A ≤150A	>150A ≤300A	>300A ≤600A	>600A ≤1200A	>1200A
			Standard Module	Power Integrated Module	Intelligent Power Module	3-level Module														
6	Small IPM	11						✓	✓					✓	✓					
6,7	IPM	12,13			✓			✓	✓	✓				✓	✓					
		14						✓	✓	✓				✓	✓	✓				
		15						✓	✓	✓					✓	✓	✓			
		16		✓				✓	✓	✓				✓						
7	Small PIM	16		✓				✓	✓	✓				✓						
	PIM EconoPIM™	17						✓	✓	✓				✓	✓					
		18		✓					✓	✓	✓				✓	✓				
6	6-Pack EconoPACK™	19						✓		✓				✓	✓	✓				
		20	✓					✓		✓	✓			✓	✓	✓	✓			
2	Standard 2-Pack	21						✓	✓	✓	✓				✓	✓	✓			
		22	✓							✓	✓					✓	✓	✓		
1	Standard 1-Pack	23	✓							✓	✓					✓	✓	✓		
	Chopper	23	✓					✓		✓					✓	✓	✓			
1,2	HPnC	24	✓								✓	✓							✓	✓
	PrimePACK™	25,26	✓							✓	✓						✓	✓	✓	
4,12	T/I-type NPC 3-level	27				✓		✓		✓	✓			✓	✓	✓	✓	✓		
2	Hybrid SiC Modules	28	✓							✓	✓					✓	✓			
	All-SiC Modules	29	✓							✓	✓	✓				✓	✓	✓		
1	Discrete IGBT	30					✓	✓	✓					✓	✓					
-	SiC-SBD	31							✓	✓	✓				✓					

注：EconoPIM™, EconoPACK™, PrimePACK™ 为 Infineon Technologies 公司的注册商标。

IGBT模块 产品型号

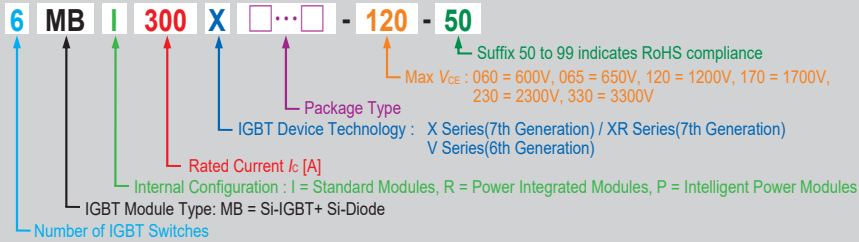

搭载SiC-SBD的IGBT混合模块

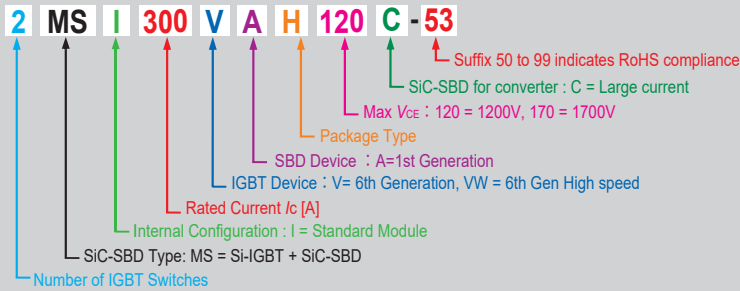

All-SiC模块 产品型号

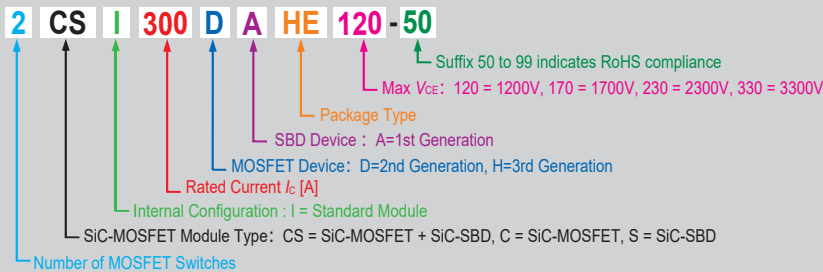

分立IGBT 产品型号

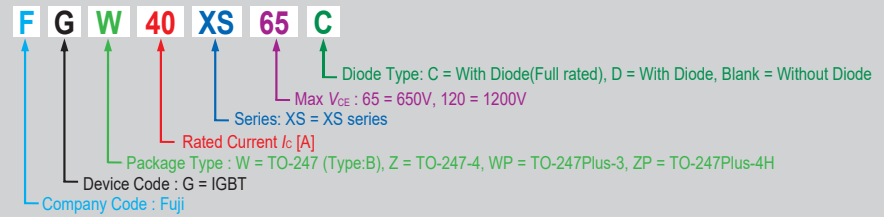
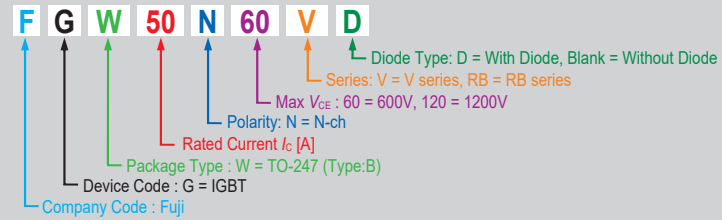

SiC肖特基势垒二极管 产品型号

•SiC-SBD 1G

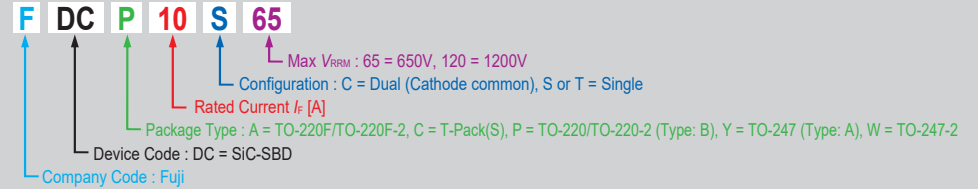

•SiC-SBD 2G

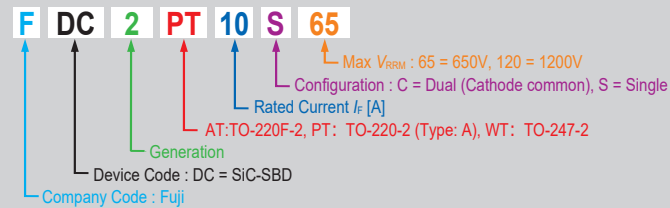

IPM (Intelligent Power Modules) 产品系列图

6/7MBP 额定 电流 Ic	IGBT series & Package type		尺寸	V series		X series		页次
	V series	X series		7 in 1	6 in 1	7 in 1	6 in 1	
	-	-	XSD, XSF, XSJ, XSK	26×43mm	-	-	-	✓
-	-	XTA, XTC	31×79mm	-	-	-	✓	11
-	-	XRVF	19×33mm	-	-	-	✓	11
-	-	XRHA	36×70mm	-	-	-	✓	12
VAA	XAA	XAA	49.5×70mm	-	✓	-	✓	12
VBA	XBA	XBA	50.2×87mm	-	✓	-	✓	12
-	XJN	XJN	50.2×87mm	-	-	✓	-	12
VFN	XFN	XFN	55×90mm	✓	✓	✓	✓	13
-	XGN	XGN	55×90mm	-	-	-	✓	13
VDA, VDN	XDA, XDN	XDA, XDN	84×128.5mm	✓	✓	✓	✓	14
VEA	XEN	XEN	110×142mm	✓	✓	✓	✓	15

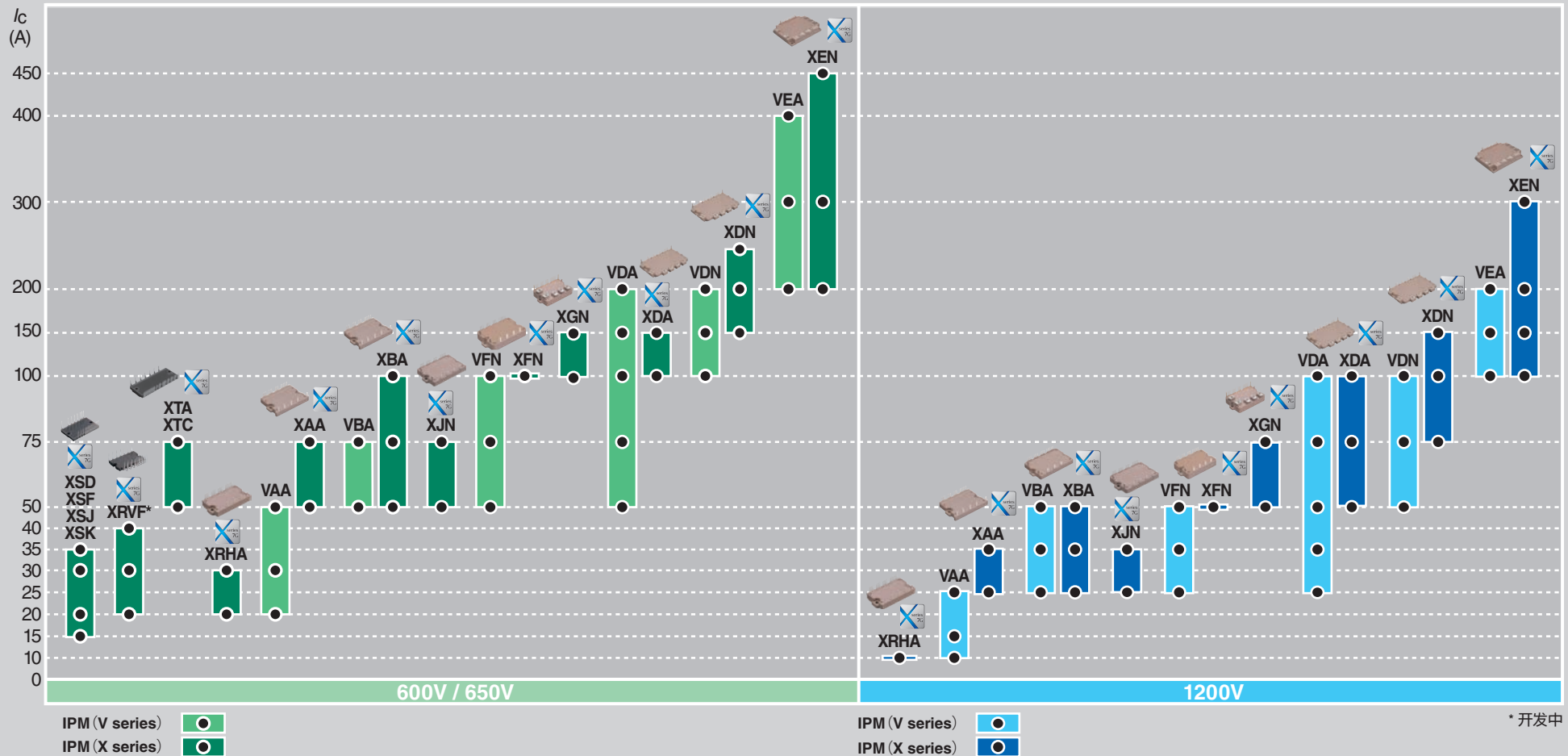

* 开发中

PIM (Power Integrated Modules) 产品系列图

7MBR	额定 电流 I_c	IGBT series & Package type				尺寸	页次	EconoPIM™
		V series		X series				
		Solder pins	Press fit pins	Solder pins	Press fit pins			
		VKC	VKA	XKC	XKA	33.8×62.8mm	16	
		VKD	VKB	XKD, XRKD	XKB, XRKB	56.7×62.8mm	16	
		VA, VM, VP	VW, VY	XM□, XP□	XW□, XY□	45×107.5mm	17,18	
		VB, VN, VR	VX, VZ	XN□, XR□	XX□, XZ□	62×122mm	17,18	

注：EconoPIM™ 为 Infineon Technologies 公司的注册商标。

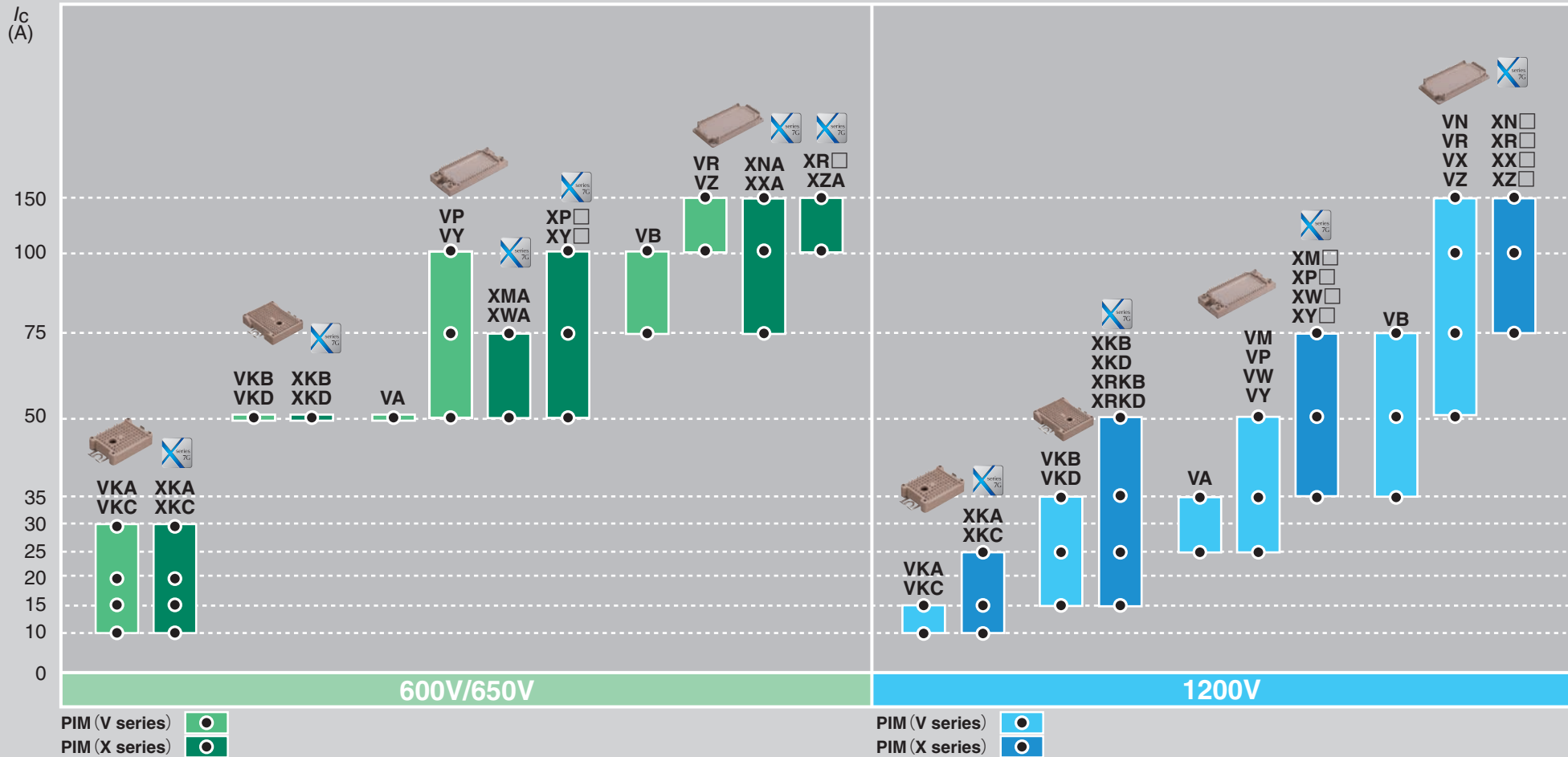

6-Pack 产品系列图

6MBI	额定 电流 I_c	IGBT series & Package type				尺寸	页次	EconoPACK™
		V series		X series				
		Solder pins	Press fit pins	Solder pins	Press fit pins			
		VA	VW	XAE	XWE	45×107.5mm	19,20	
		VB	VX	XB□	XX□	62×122mm	19,20	

注：EconoPACK™ 为 Infineon Technologies 公司的注册商标。

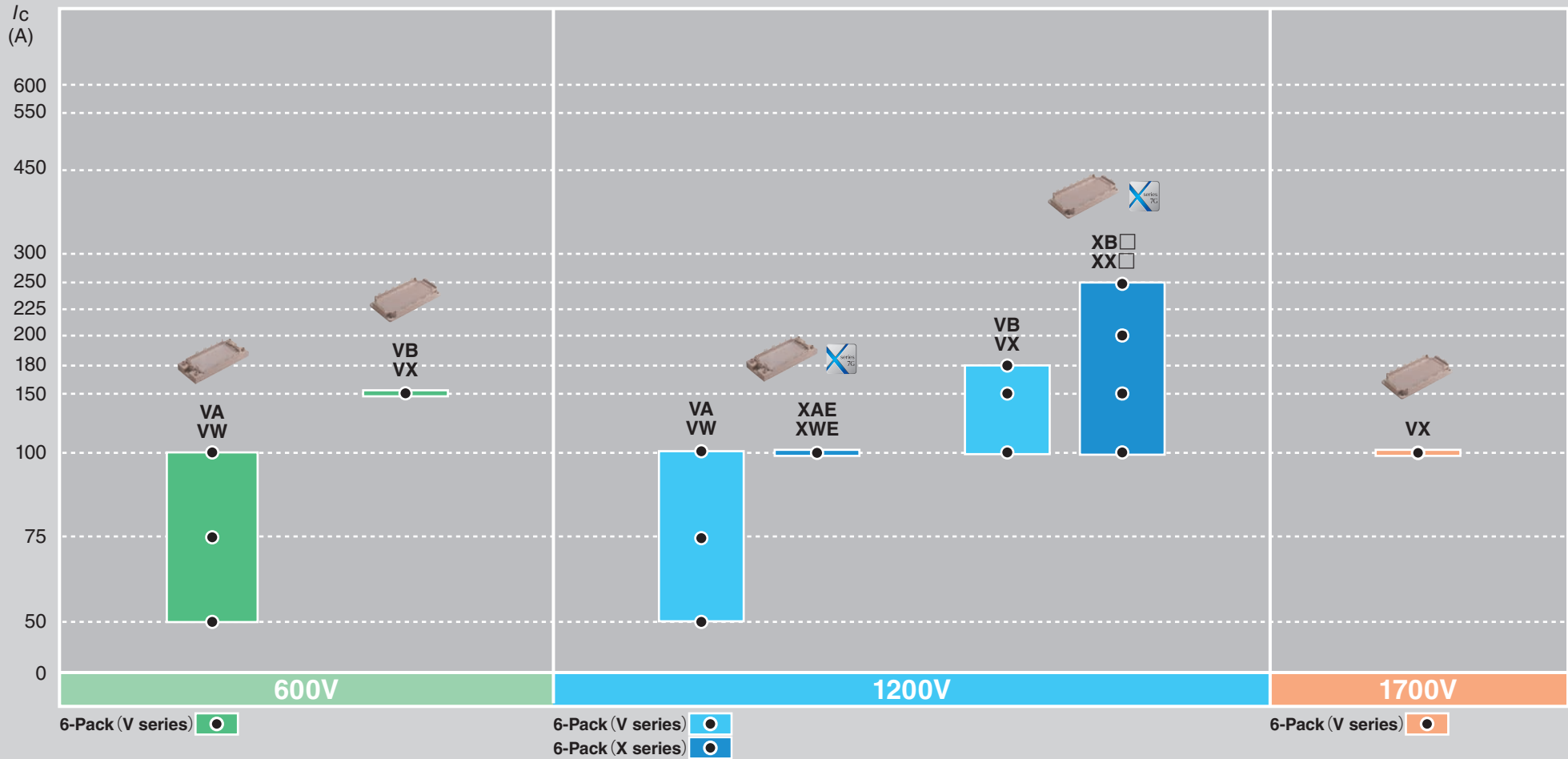

2-Pack (IGBT 模块) 产品系列图

2MBI 额定 电流 I_c	IGBT series & Package type		尺寸	页次	
	V series	X series			
	VA	XAA	34×94mm	21	Standard Pack
	VB	XBE	45×92mm	21	
	VD, VH	XDE, XHA	62×108mm	21	
	VE	XEE	80×110mm	21	
	VN, VX	XN□, XRN□	62×150mm	22	
	-	XYF, XZF	99.5×140mm	24	HPnC
	VXA	XXA, XXE	89×172mm	25	PrimePACK™
	VXB	XXB, XXF, XXG, XRXG	89×250mm	25	

注：PrimePACK™ 为 Infineon Technologies 公司的注册商标。

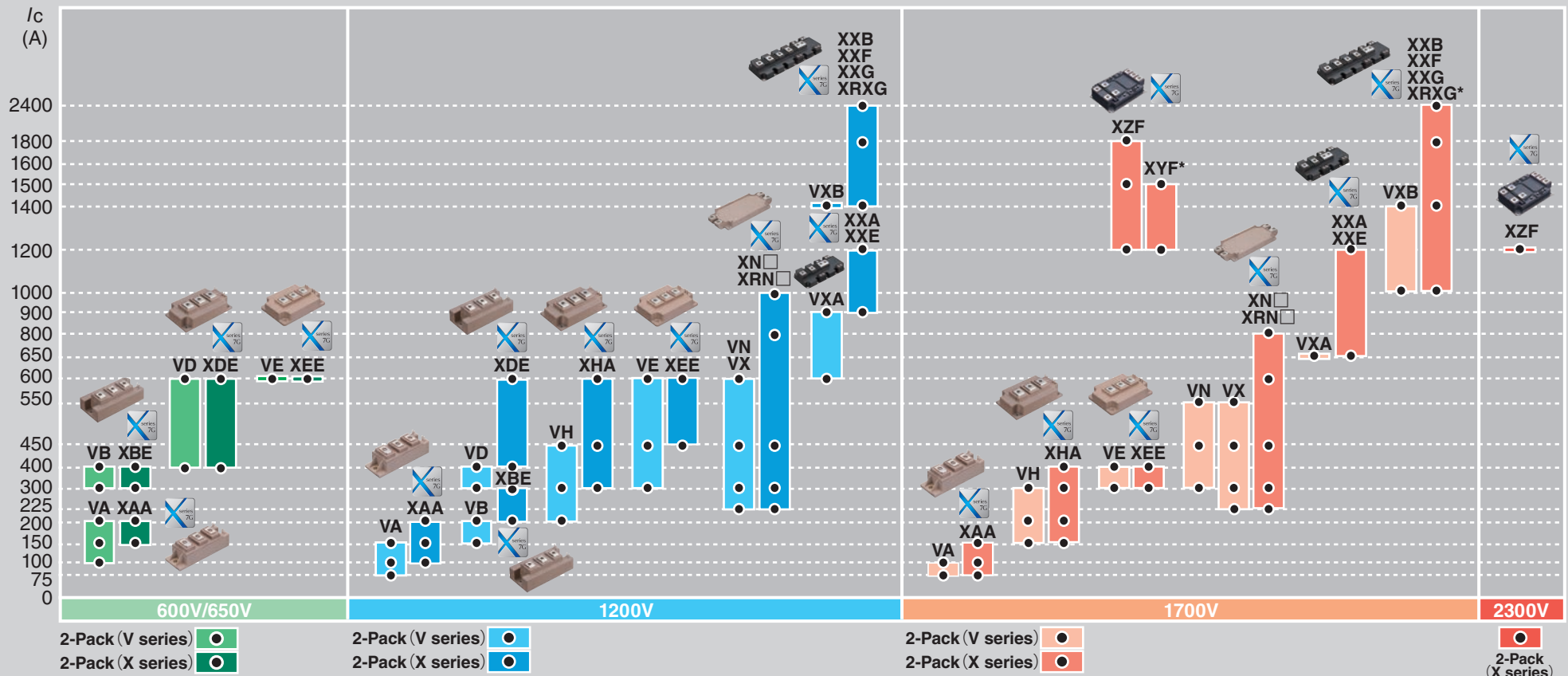

2-Pack (SiC 模块) 产品系列图

2MSI 2CI	额定 电流 I_c	IGBT Hybrid series & Package type		尺寸	页次	
		IGBT Hybrid Modules with SiC-SBD V series	IGBT Hybrid Modules with SiC-SBD VW series			
		VAB	-	45×92mm	28	Standard Pack
		VAH	VWAH	62×108mm	28	
		VAE	-	80×110mm	28	
		VAN	-	62×150mm	28	Dual XT
2CSI 2CI	额定 电流 I_c	All-SiC series & Package type		尺寸	页次	
		2G SiC-MOSFET Modules with 1G SiC-SBD	3G SiC-MOSFET Modules			
			DAHE	-	62×108mm	29
	-	-	HYF, HZF	99.5×144mm	29	HPnC

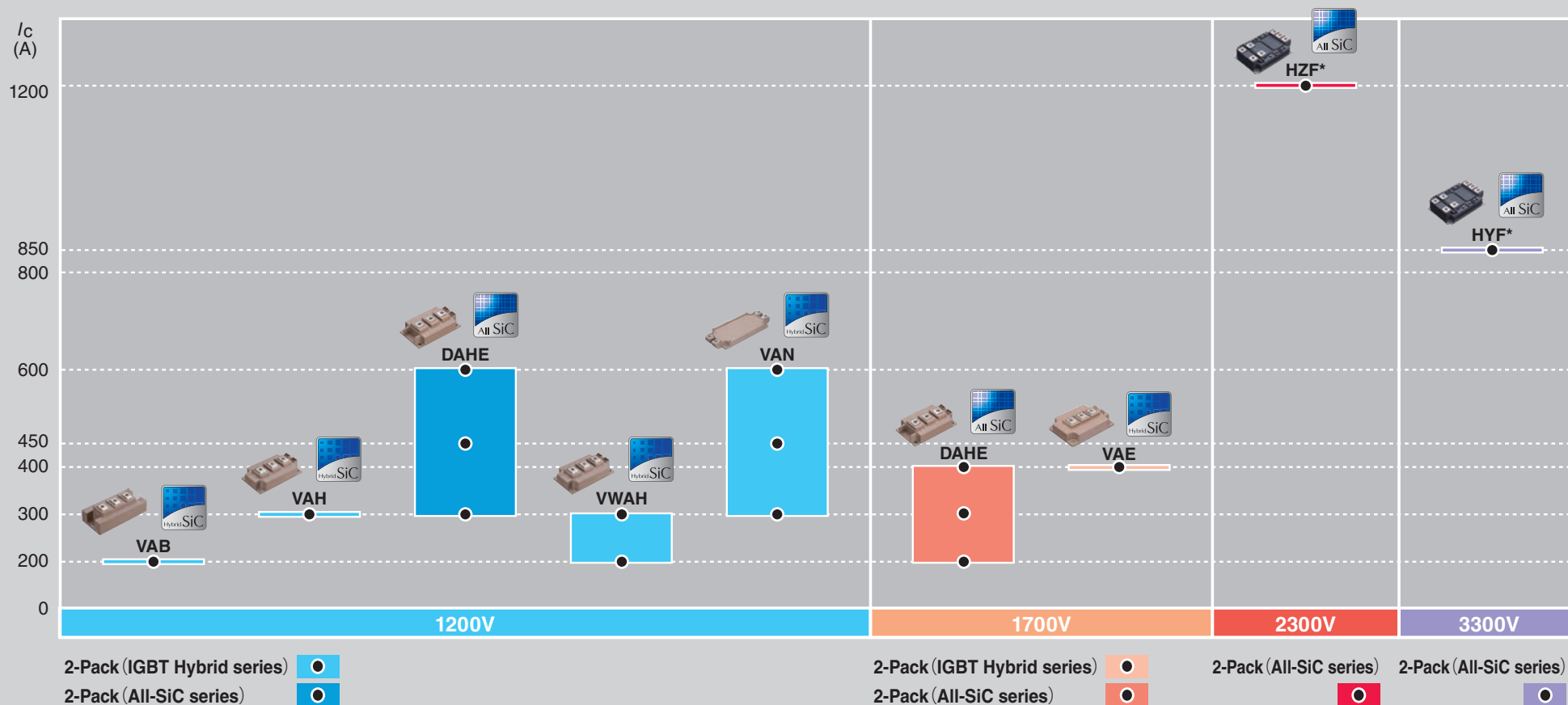

* 开发中

1-Pack 产品系列图

1MBI	额定 电流 I_c	IGBT series & Package type		尺寸	页次	Standard Pack
		V series				
		V				
				62×108mm	23	Standard Pack

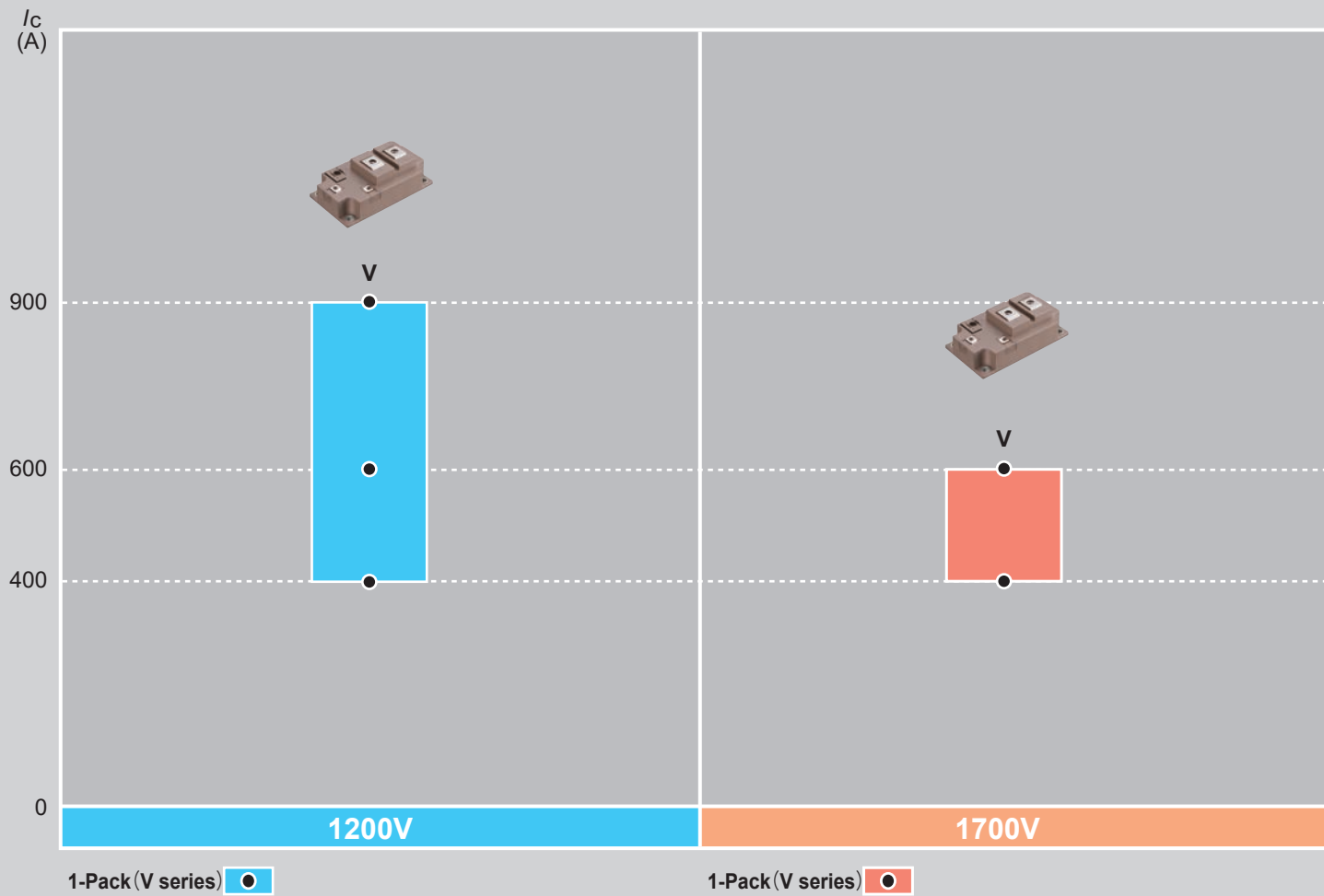

Small IPM (Intelligent Power Modules)

Built-in protection functions

- P-side fault status output (Alarm)
- N-side fault status output (Alarm)
- Under voltage protection (self shutdown)
- Over current protection (self shutdown)
- Overheating protection (self shutdown)
- Temperature sensor output (Vtemp, out)

外形尺寸 [mm]

600 / 650V



Small IPM with High Voltage Driver-IC without Brake-Chopper

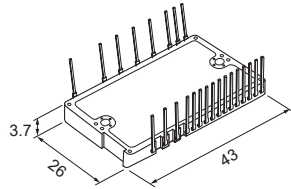

P633A

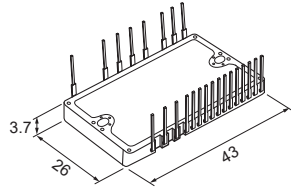
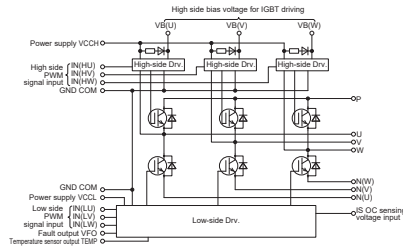

P633C

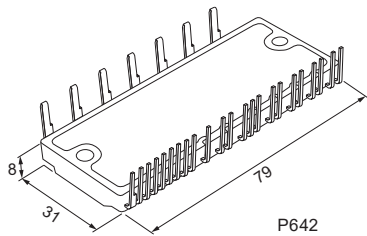
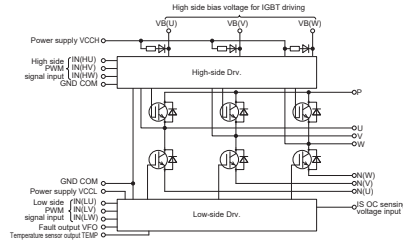

P642

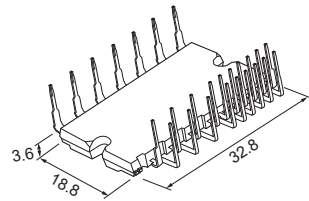
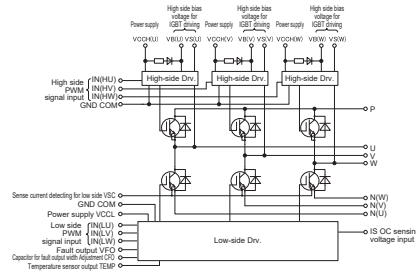

P641

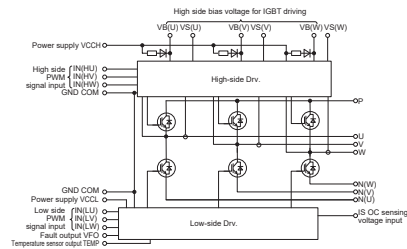

IC	X series	1	2	3	4	5	6
15A	6MBP15XSD060-50	✓	—	✓	✓	✓	—
20A	6MBP20XSD060-50						
30A	6MBP30XSD060-50						
35A	6MBP35XSD060-50						
15A	6MBP15XSF060-50						
20A	6MBP20XSF060-50	✓	✓	✓	✓	✓	—
30A	6MBP30XSF060-50						
35A	6MBP35XSF060-50						
15A	6MBP15XSJ065-50						
20A	6MBP20XSJ065-50	✓	—	✓	✓	✓	—
30A	6MBP30XSJ065-50						
35A	6MBP35XSJ065-50						
15A	6MBP15XSK065-50						
20A	6MBP20XSK065-50	✓	✓	✓	✓	✓	—
30A	6MBP30XSK065-50						
35A	6MBP35XSK065-50						
50A	6MBP50XTA065-50						
75A	6MBP75XTA065-50	✓	—	✓	✓	✓	—
50A	6MBP50XTC065-50						
75A	6MBP75XTC065-50	✓	✓	✓	✓	✓	—
20A	6MBP20XRVF065-50*						
30A	6MBP30XRVF065-50*	✓	✓	✓	✓	✓	—
40A	6MBP40XRVF065-50*						

* 开发中

Built-in protection functions

- P-side fault status output (Alarm)
- N-side fault status output (Alarm)
- Under voltage protection (self shutdown)
- Over current protection (self shutdown)
- Overheating protection (self shutdown)

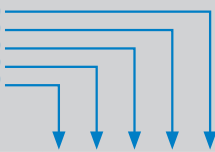

IPM (Intelligent Power Modules)

外形尺寸 [mm]

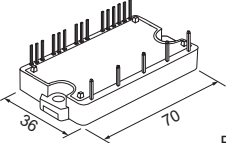
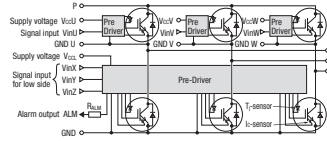
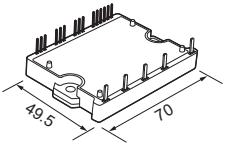
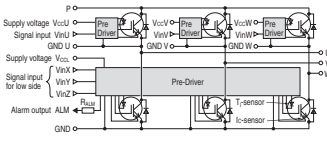
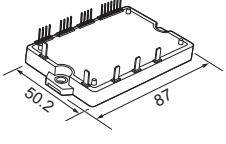
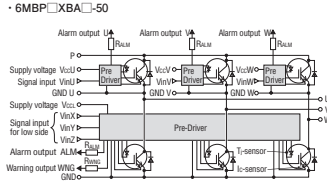
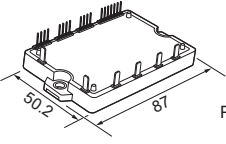
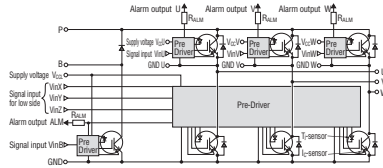
	外形尺寸 [mm]	P-side fault status output (Alarm)	N-side fault status output (Alarm)	Under voltage protection (self shutdown)	Over current protection (self shutdown)	Overheating protection (self shutdown)	650V		600V		1200V	
							X series	V series	X series	V series		
Without Brake-Chopper  <p>P639</p> 	36 x 70	✓	✓	✓	✓	—	10A				6MBP10XRHA120-50	
							20A	6MBP20XRHA065-50				
							30A	6MBP30XRHA065-50				
Without Brake-Chopper  <p>P629</p> 	49.5 x 70	✓	✓	✓	✓	—	10A					6MBP10VAA120-50
							15A					6MBP15VAA120-50
							20A		6MBP20VAA060-50			
							25A			6MBP25XAA120-50		6MBP25VAA120-50
							30A		6MBP30VAA060-50			
							35A			6MBP35XAA120-50		
							50A	6MBP50XAA065-50	6MBP50VAA060-50			
Without Brake-Chopper  <p>P626</p> 	50.2 x 87	✓	✓	✓	✓	✓	25A				6MBP25XBA120-50	6MBP25VBA120-50
							35A				6MBP35XBA120-50	6MBP35VBA120-50
								50A	6MBP50XBA065-50	6MBP50VBA060-50	6MBP50XBA120-50	6MBP50VBA120-50
								75A	6MBP75XBA065-50	6MBP75VBA060-50		
								100A	6MBP100XBA065-50			
With Brake-Chopper  <p>P644</p> 	50.2 x 87	✓	✓	✓	✓	✓	25A				7MBP25XJN120-50	
							35A				7MBP35XJN120-50	
								50A	7MBP50XJN065-50			
								75A	7MBP75XJN065-50			

Built-in protection functions

- P-side fault status output (Alarm)
- N-side fault status output (Alarm)
- Under voltage protection (self shutdown)
- Over current protection (self shutdown)
- Overheating protection (self shutdown)

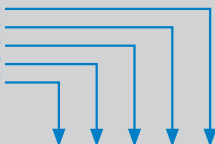

IPM (Intelligent Power Modules)

外形尺寸 [mm]

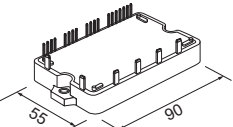
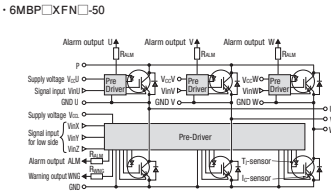
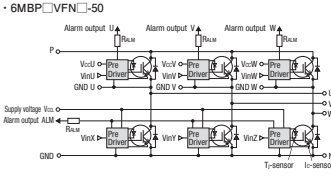
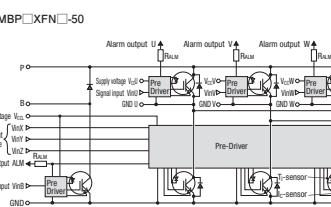
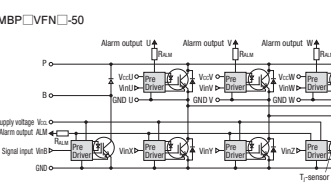
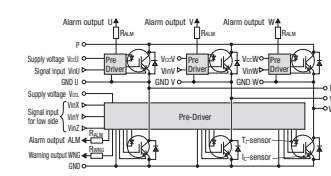
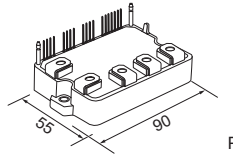
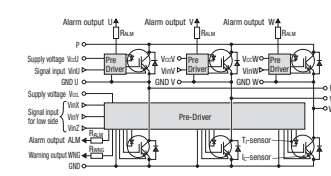
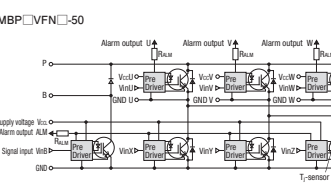
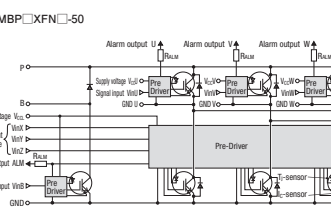
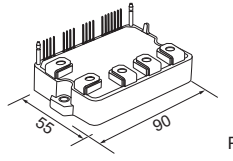
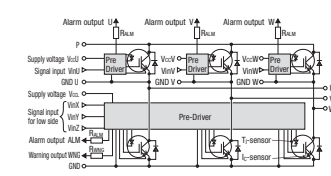
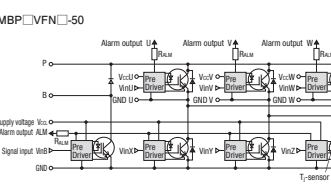
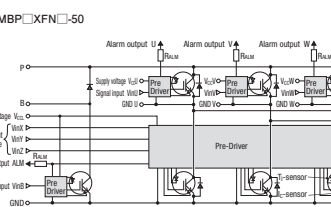
	外形尺寸 [mm]	P-side fault status output (Alarm)	N-side fault status output (Alarm)	Under voltage protection (self shutdown)	Over current protection (self shutdown)	Overheating protection (self shutdown)	650V		600V		1200V			
							X series	X series 7G	V series	X series	X series 7G	V series		
Without Brake-Chopper	 P636	 • 6MBP□XFN□-50	✓	✓	✓	✓	✓							
			 • 6MBP□VFN□-50	✓	✓	✓	✓							
			 • 7MBP□XFN□-50	✓	✓	✓	✓							
			 • 7MBP□VFN□-50	✓	✓	✓	✓							
			 • 7MBP□XFN□-50	✓	✓	✓	✓							
With Brake-Chopper	 P638	 • 7MBP□XFN□-50	✓	✓	✓	✓								
			 • 7MBP□VFN□-50	✓	✓	✓	✓							
			 • 7MBP□XFN□-50	✓	✓	✓	✓							
Without Brake-Chopper	 P638	 • 7MBP□XFN□-50	✓	✓	✓	✓								
			 • 7MBP□VFN□-50	✓	✓	✓	✓							
			 • 7MBP□XFN□-50	✓	✓	✓	✓							

Built-in protection functions

- P-side fault status output (Alarm)
- N-side fault status output (Alarm)
- Under voltage protection (self shutdown)
- Over current protection (self shutdown)
- Overheating protection (self shutdown)

IPM (Intelligent Power Modules)

外形尺寸 [mm]

Without Brake-Chopper

With Brake-Chopper

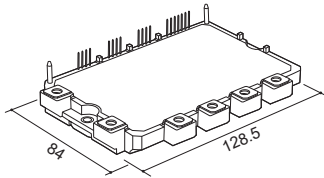

P630

- 6MBP□XDA□-50
- 6MBP□XDN□-50

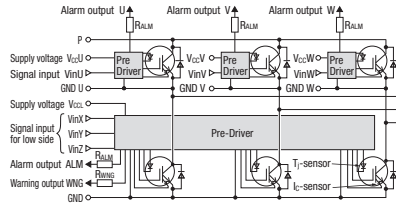

- 6MBP□VDA□-50
- 6MBP□VDN□-50

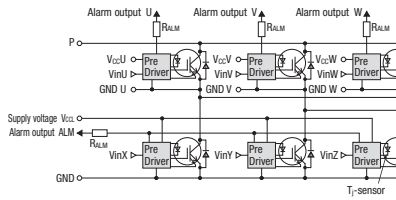

- 7MBP□XDA□-50
- 7MBP□XDN□-50

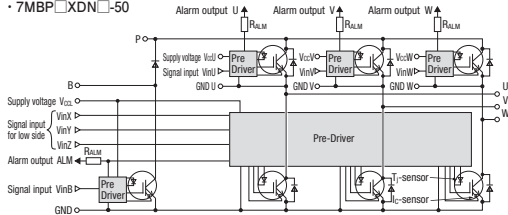

- 7MBP□VDA□-50
- 7MBP□VDN□-50

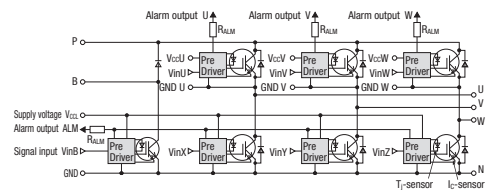

Ic	650V		600V		1200V	
	X series	X series 7G	V series	X series	X series 7G	V series
25A						6MBP25VDA120-50
35A						6MBP35VDA120-50
50A			6MBP50VDA060-50		6MBP50XDA120-50	6MBP50VDA120-50
75A			6MBP75VDA060-50		6MBP75XDA120-50	6MBP75VDA120-50
100A	6MBP100XDA065-50		6MBP100VDA060-50	6MBP100XDA120-50	6MBP100XDA120-50	6MBP100VDA120-50
			6MBP100VDN060-50	6MBP100XDN120-50	6MBP100XDN120-50	6MBP100VDN120-50
150A	6MBP150XDA065-50		6MBP150VDA060-50			
	6MBP150XDN065-50		6MBP150VDN060-50	6MBP150XDN120-50	6MBP150XDN120-50	
200A			6MBP200VDA060-50			
	6MBP200XDN065-50		6MBP200VDN060-50			
250A						
	6MBP250XDN065-50					
25A						7MBP25VDA120-50
35A						7MBP35VDA120-50
50A			7MBP50VDA060-50		7MBP50XDA120-50	7MBP50VDA120-50
						7MBP50VDN120-50
75A			7MBP75VDA060-50		7MBP75XDA120-50	7MBP75VDA120-50
					7MBP75XDN120-50	7MBP75VDN120-50
100A	7MBP100XDA065-50		7MBP100VDA060-50	7MBP100XDA120-50	7MBP100XDA120-50	7MBP100VDA120-50
			7MBP100VDN060-50	7MBP100XDN120-50	7MBP100XDN120-50	7MBP100VDN120-50
150A	7MBP150XDA065-50		7MBP150VDA060-50		7MBP150XDN120-50	
	7MBP150XDN065-50		7MBP150VDN060-50			
200A			7MBP200VDA060-50			
	7MBP200XDN065-50		7MBP200VDN060-50			
250A						
	7MBP250XDN065-50					

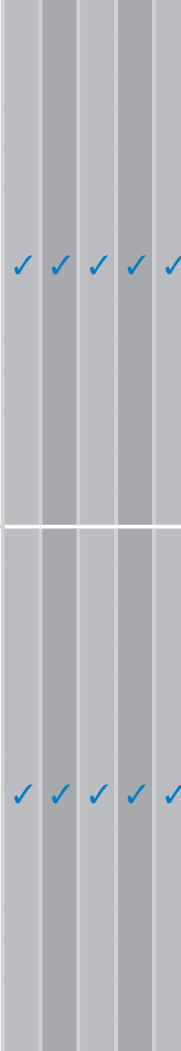

注：本页中带有 VDN, XDN 的型号使用低热阻封装。

Built-in protection functions

- P-side fault status output (Alarm)
- N-side fault status output (Alarm)
- Under voltage protection (self shutdown)
- Over current protection (self shutdown)
- Overheating protection (self shutdown)

IPM (Intelligent Power Modules)

外形尺寸 [mm]

Without Brake-Chopper

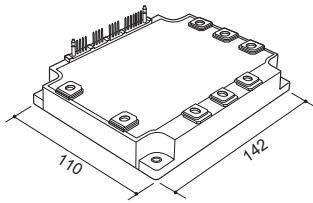

P631

With Brake-Chopper

• 6MBP□XEN□-50

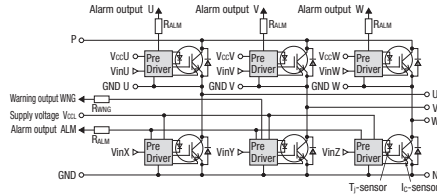

• 6MBP□VEA□-50

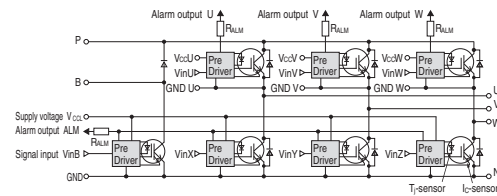
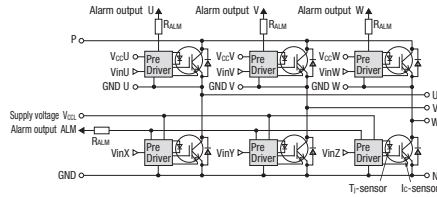

I_c

100A
150A
200A
300A
400A
450A

I _c	650V		600V		1200V	
	X series		V series		X series	V series
100A					6MBP100XEN120-50	6MBP100VEA120-50
150A					6MBP150XEN120-50	6MBP150VEA120-50
200A	6MBP200XEN065-50		6MBP200VEA060-50		6MBP200XEN120-50	6MBP200VEA120-50
300A	6MBP300XEN065-50		6MBP300VEA060-50		6MBP300XEN120-50	
400A			6MBP400VEA060-50			
450A	6MBP450XEN065-50					
100A					7MBP100XEN120-50	7MBP100VEA120-50
150A					7MBP150XEN120-50	7MBP150VEA120-50
200A	7MBP200XEN065-50		7MBP200VEA060-50		7MBP200XEN120-50	7MBP200VEA120-50
300A	7MBP300XEN065-50		7MBP300VEA060-50		7MBP300XEN120-50	
400A			7MBP400VEA060-50			
450A	7MBP450XEN065-50					

Small PIM (Power Integrated Modules)

外形尺寸 [mm]

With NTC, Press fit pins

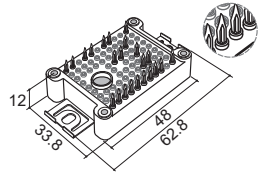

X: M730, V: M726

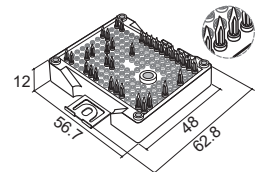
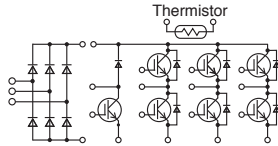

X: M731, V: M727

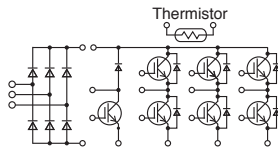

XKB, VKB

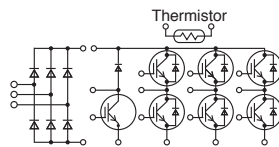

XRKB

With NTC, Solder pins

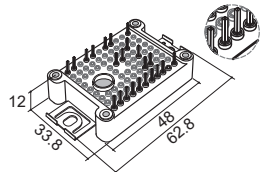

X: M732, V: M728

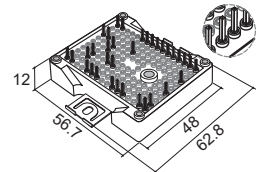
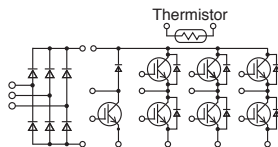

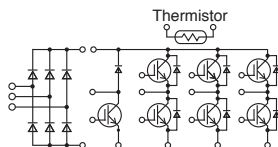

X: M733, V: M729

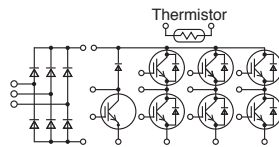

XKD, VKD



XRKD

Ic	650V		600V		1200V	
	X series	 7G	V series	 7G	V series	V series
10A	7MBR10XKA065-50		7MBR10VKA060-50		7MBR10XKA120-50	7MBR10VKA120-50
15A	7MBR15XKA065-50		7MBR15VKA060-50		7MBR15XKA120-50	7MBR15VKA120-50
20A	7MBR20XKA065-50		7MBR20VKA060-50			
25A					7MBR25XKA120-50	
30A	7MBR30XKA065-50		7MBR30VKA060-50			
15A					7MBR15XKB120-50	7MBR15VKB120-50
25A					7MBR25XKB120-50	7MBR25VKB120-50
35A					7MBR35XKB120-50	7MBR35VKB120-50
50A	7MBR50XKB065-50		7MBR50VKB060-50		7MBR50XRKB120-50	
10A	7MBR10XKC065-50		7MBR10VKC060-50		7MBR10XKC120-50	7MBR10VKC120-50
15A	7MBR15XKC065-50		7MBR15VKC060-50		7MBR15XKC120-50	7MBR15VKC120-50
20A	7MBR20XKC065-50		7MBR20VKC060-50			
25A					7MBR25XKC120-50	
30A	7MBR30XKC065-50		7MBR30VKC060-50			
15A					7MBR15XKD120-50	7MBR15VKD120-50
25A					7MBR25XKD120-50	7MBR25VKD120-50
35A					7MBR35XKD120-50	7MBR35VKD120-50
50A	7MBR50XKD065-50		7MBR50VKD060-50		7MBR50XRKD120-50	

PIM (Power Integrated Modules) EconoPIM™ 外形尺寸 [mm]

With NTC, Solder pins, PIM

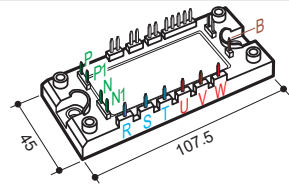

M711

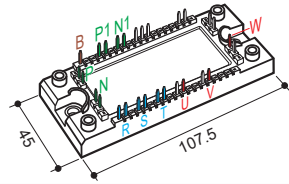
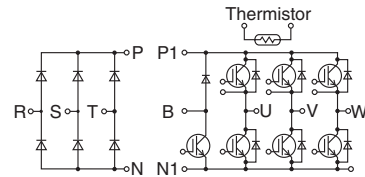

M719

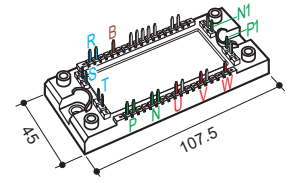
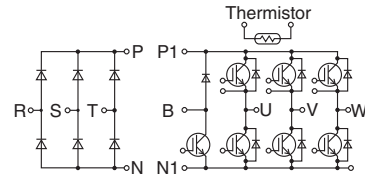

M719

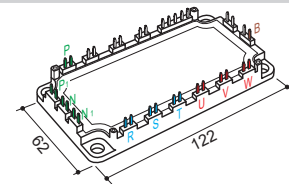
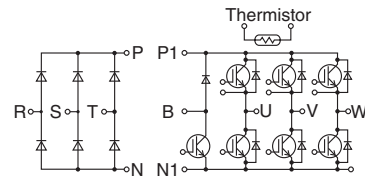

M712

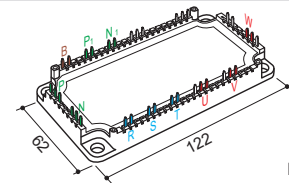
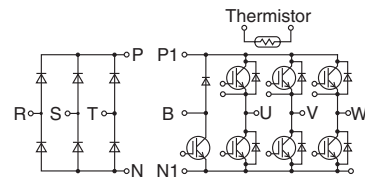

M720

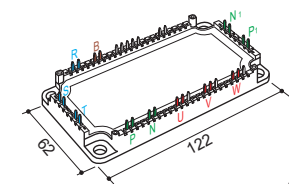
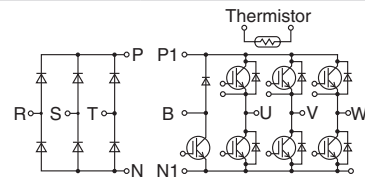

M720

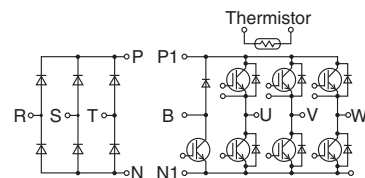

Ic	650V		600V		1200V	
	X series		V series		X series	
25A						7MBR25VA120-50
35A						7MBR35VA120-50
50A			7MBR50VA060-50			
25A						7MBR25VM120-50
35A					7MBR35XMA120-50	7MBR35VM120-50
50A	7MBR50XMA065-50				7MBR50XMA120-50	7MBR50VM120-50
75A	7MBR75XMA065-50				7MBR75XME120-50	
25A						7MBR25VP120-50
35A					7MBR35XPA120-50	7MBR35VP120-50
50A	7MBR50XPA065-50		7MBR50VP060-50		7MBR50XPA120-50	7MBR50VP120-50
75A	7MBR75XPA065-50		7MBR75VP060-50		7MBR75XPE120-50	
100A	7MBR100XPE065-50		7MBR100VP060-50		7MBR75XPE120-50	
35A						7MBR35VB120-50
50A						7MBR50VB120-50
75A			7MBR75VB060-50			7MBR75VB120-50
100A			7MBR100VB060-50			
50A						7MBR50VN120-50
75A	7MBR75XNA065-50				7MBR75XNA120-50	7MBR75VN120-50
100A	7MBR100XNA065-50				7MBR100XNA120-50	7MBR100VN120-50
150A	7MBR150XNA065-50				7MBR150XNE120-50	7MBR150VN120-50
50A						7MBR50VR120-50
75A					7MBR75XRA120-50	7MBR75VR120-50
100A	7MBR100XRA065-50		7MBR100VR060-50		7MBR100XRA120-50	7MBR100VR120-50
150A	7MBR150XRA065-50		7MBR150VR060-50		7MBR150XRE120-50	7MBR150VR120-50
	7MBR150XRE065-50					

注 1 : EconoPIM™ 为 Infineon Technologies 公司的注册商标。

6-Pack EconoPACK™

外形尺寸 [mm]

With NTC, Solder pins

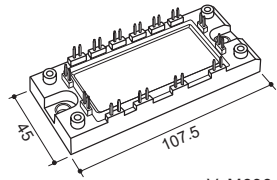

V: M636

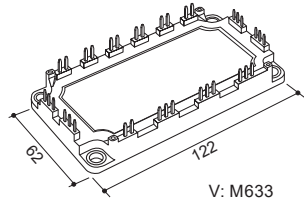
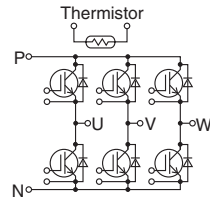

V: M633

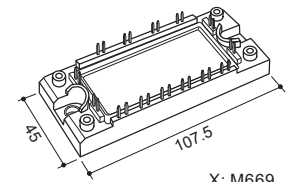
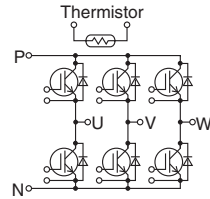

X: M669

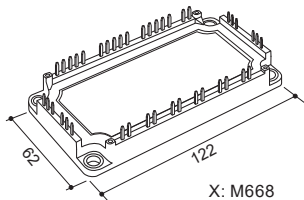
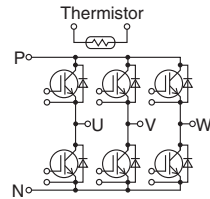

X: M668

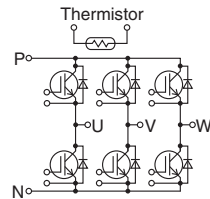

Ic	600V		1200V	
	V series	X series	X series	V series
50A	6MBI50VA-060-50			6MBI50VA-120-50
75A	6MBI75VA-060-50			6MBI75VA-120-50
100A	6MBI100VA-060-50			6MBI100VA-120-50
100A				6MBI100VB-120-50
150A	6MBI150VB-060-50			6MBI150VB-120-50
180A				6MBI180VB-120-50
				6MBI180VB-120-55
100A		6MBI100XAE120-50		
100A		6MBI100XBA120-50		
150A		6MBI150XBA120-50		
200A		6MBI200XBA120-50		
		6MBI200XBE120-50		

注 1 : 6MBI180VB-120-55 使用低热阻封装

注 2 : EconoPACK™ 为 Infineon Technologies 公司的注册商标。

6-Pack EconoPACK™

外形尺寸 [mm]

With NTC, Press fit pins

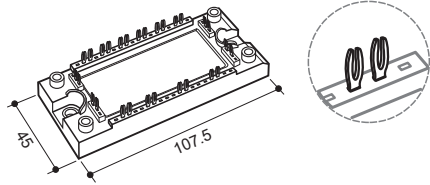

M647

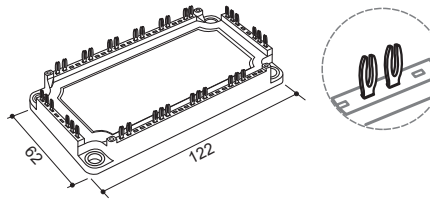
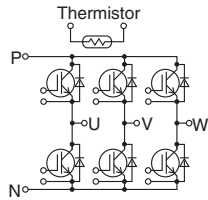

M648

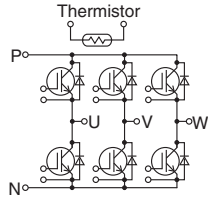

Ic	600V	1200V		1700V
	V series	X series 	V series	V series
50A	6MBI50VW-060-50		6MBI50VW-120-50	
75A	6MBI75VW-060-50		6MBI75VW-120-50	
100A	6MBI100VW-060-50	6MBI100XWE120-50	6MBI100VW-120-50	
100A		6MBI100XXA120-50	6MBI100VX-120-50	6MBI100VX-170-50
150A	6MBI150VX-060-50	6MBI150XXA120-50	6MBI150VX-120-50	
180A			6MBI180VX-120-50	
			6MBI180VX-120-55	
200A		6MBI200XXA120-50		
		6MBI200XXE120-50		

注 1 : 6MBI180VX-120-55 使用低热阻封装
 注 2 : EconoPACK™ 为 Infineon Technologies 公司的注册商标。

Standard 2-Pack

外形尺寸 [mm]

2-Pack

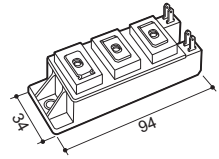

M263

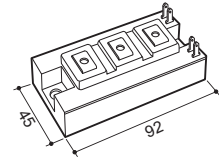
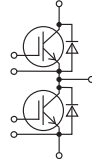

M274

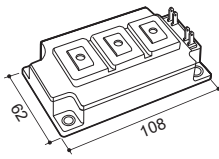
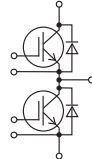

M275

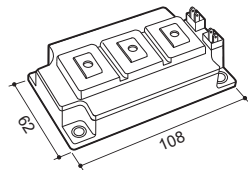
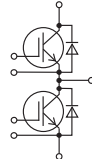

M276

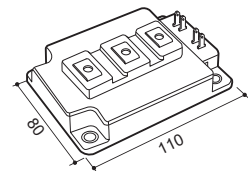
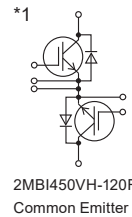
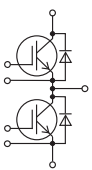

M277

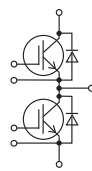

Ic	650V		600V		1200V		1700V	
	X series	V series	X series	V series	X series	V series	X series	V series
75A								
100A		2MBI100VA-060-50	2MBI100XAA120-50	2MBI100VA-120-50	2MBI100XAA170-50	2MBI100VA-170-50		
150A	2MBI150XAA065-50	2MBI150VA-060-50	2MBI150XAA120-50	2MBI150VA-120-50	2MBI150XAA170-50	2MBI150VA-170-50		
200A	2MBI200XAA065-50	2MBI200VA-060-50	2MBI200XAA120-50					
150A						2MBI150VB-120-50		
200A					2MBI200XBE120-50	2MBI200VB-120-50		
300A	2MBI300XBE065-50	2MBI300VB-060-50	2MBI300XBE120-50					
400A	2MBI400XBE065-50	2MBI400VB-060-50						
300A						2MBI300VD-120-50		
400A	2MBI400XDE065-50	2MBI400VD-060-50	2MBI400XDE120-50	2MBI400VD-120-50				
600A	2MBI600XDE065-50	2MBI600VD-060-50	2MBI600XDE120-50					
150A							2MBI150XHA170-50	2MBI150VH-170-50
200A						2MBI200VH-120-50	2MBI200XHA170-50	2MBI200VH-170-50
300A					2MBI300XHA120-50	2MBI300VH-120-50	2MBI300XHA170-50	2MBI300VH-170-50
400A							2MBI400XHA170-50	
450A					2MBI450XHA120-50	2MBI450VH-120-50		
600A					2MBI600XHA120-50	2MBI450VH-120F-50 ^{*1}		
300A						2MBI300VE-120-50	2MBI300XEE170-50	2MBI300VE-170-50
400A							2MBI400XEE170-50	2MBI400VE-170-50
450A					2MBI450XEE120-50	2MBI450VE-120-50		
600A	2MBI600XEE065-50	2MBI600VE-060-50	2MBI600XEE120-50	2MBI600VE-120-50				

Standard 2-Pack

外形尺寸 [mm]

With NTC, Solder pins

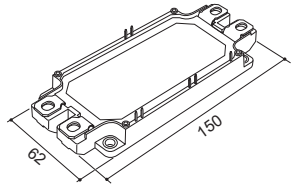

M254

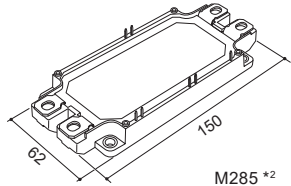
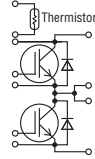

M285 *2

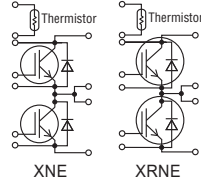

With NTC, Press fit pins

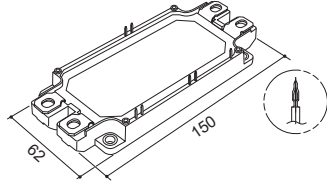

M282

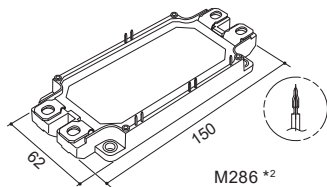
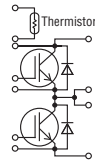

M286 *2

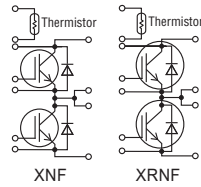

Ic	1200V			1700V		
	X series	V series	V series With SiN substrate *1	X series	V series	V series With SiN substrate *1
225A	2MBI225XNA120-50	2MBI225VN-120-50	2MBI225VN-120S-50	2MBI225XNA170-50		
300A	2MBI300XNA120-50	2MBI300VN-120-50	2MBI300VN-120S-50	2MBI300XNA170-50	2MBI300VN-170-50	
450A	2MBI450XNA120-50	2MBI450VN-120-50	2MBI450VN-120S-50	2MBI450XNA170-50	2MBI450VN-170-50	
550A						2MBI550VN-170-50
600A	2MBI600XNG120-50 *1		2MBI600VN-120-50	2MBI600XNG170-50 *1		
600A	2MBI600XNE120-50 *1			2MBI600XNE170-50 *1		
800A	2MBI800XNE120-50 *1			2MBI800XNE170-50 *1		
1000A	2MBI1000XRNE120-50 *1					
225A	2MBI225XNB120-50	2MBI225VX-120-50		2MBI225XNB170-50	2MBI225VX-170-50	
300A	2MBI300XNB120-50	2MBI300VX-120-50		2MBI300XNB170-50	2MBI300VX-170-50	
450A	2MBI450XNB120-50	2MBI450VX-120-50		2MBI450XNB170-50	2MBI450VX-170-50	
550A						2MBI550VX-170-50
600A	2MBI600XNH120-50 *1		2MBI600VX-120-50	2MBI600XNH170-50 *1		
600A	2MBI600XNF120-50 *1			2MBI600XNF170-50 *1		
800A	2MBI800XNF120-50 *1			2MBI800XNF170-50 *1		
1000A	2MBI1000XRNF120-50 *1					

*1 低热阻封装

*2 高放热、高耐电蚀性封装

Standard 1-Pack

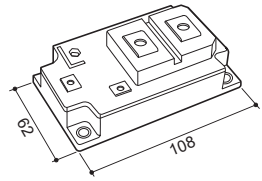

M153

外形尺寸 [mm]

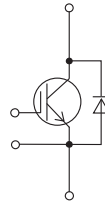

I_c

1200V

1700V

V series

V series

V series

with AlN substrate

I _c	V series	V series with AlN substrate	V series
400A	1MBI400V-120-50	1MBI400VF-120-50	1MBI400V-170-50
600A	1MBI600V-120-50	1MBI600VF-120-50	1MBI600V-170-50
900A	1MBI900V-120-50		

Chopper

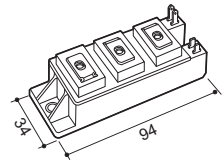

M262

外形尺寸 [mm]

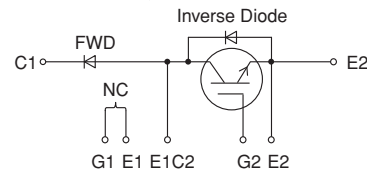

I_c

600V

1200V

V series

V series

I _c	V series	V series
150A		1MBI150VA-120L-50
200A		1MBI200VA-120L-50
400A	1MBI400VH-060L-50	

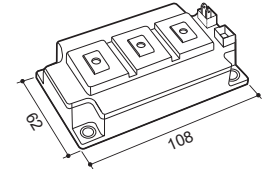

M283

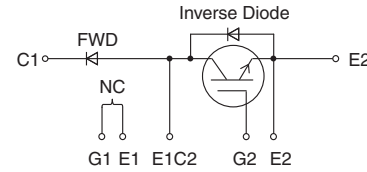

High Power Module HPnC

外形尺寸 [mm]

2-Pack

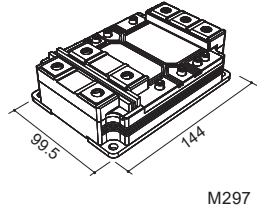

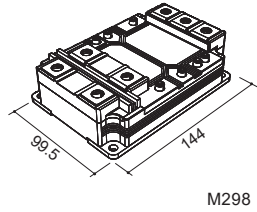
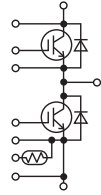

M297

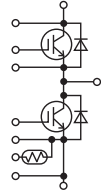

M298



Ic	1700V 		2300V 	
	X series		X series	
1200A	2MBI1200XYF170-50*			
1500A	2MBI1500XYF170-50*			
1200A	2MBI1200XZF170-50		2MBI1200XZF230-50	
1500A	2MBI1500XZF170-50			
1800A	2MBI1800XZF170-50			

注 1 : M297: MgSiC-baseplate, M298: Cu-baseplate

* 开发中

PrimePACK™

外形尺寸 [mm]

Ic

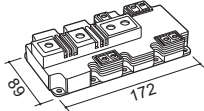
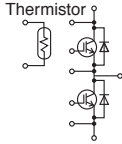
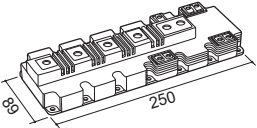
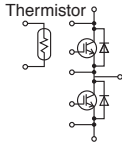
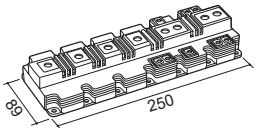
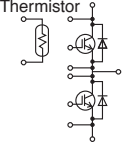
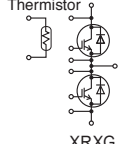
	外形尺寸 [mm]	Ic	1200V			1700V		
			X series	V series		X series	V series	
			Soft turn off	Low switching loss	Soft turn off		Low switching loss	Soft turn off
 <p>M271</p> 	89 172	600A		2MBI600VXA-120E-50 2MBI600VXA-120E-54				
		650A				2MBI650XXA170-50	2MBI650VXA-170E-50 2MBI650VXA-170E-54 2MBI650VXA-170EA-50 2MBI650VXA-170EA-54	
		900A	2MBI900XXA120P-50	2MBI900VXA-120E-50 2MBI900VXA-120E-54	2MBI900VXA-120P-50 2MBI900VXA-120P-54			
		1200A	2MBI1200XXE120P-50			2MBI1200XXE170-50		
		1000A				2MBI1000XXB170-50	2MBI1000VXB-170E-50 2MBI1000VXB-170E-54 2MBI1000VXB-170EA-50 2MBI1000VXB-170EA-54	
 <p>M272</p> 	89 250	1400A	2MBI1400XXB120P-50	2MBI1400VXB-120E-50 2MBI1400VXB-120E-54	2MBI1400VXB-120P-50 2MBI1400VXB-120P-54	2MBI1400XXB170-50	2MBI1400VXB-170E-50 2MBI1400VXB-170E-54 2MBI1400VXB-170EA-50 2MBI1400VXB-170EA-54	
		1800A	2MBI1800XXF120P-50			2MBI1800XXF170-50		
		1800A	2MBI1800XXG120P-50			2MBI1800XXG170-50		
 <p>M291</p>  	89 250	2400A	2MBI2400XRXG120-50			2MBI2400XRXG170-50*		

注 1 : -54 : $V_{CE(sat)}$ 和 V_F 的等级会显示在标签中
 注 2 : 带 EA 的型号降低了 V_F 和热阻, 可支持对二极管负荷较大的应用。
 注 3 : PrimePACK™ 为 Infineon Technologies 公司的注册商标。
 注 4 : 本页带 “P” 的产品为 “soft turn off” 类型

* 开发中

PrimePACK™

外形尺寸 [mm]

I_c

1200V

1700V

V series

V series

Low side configuration

High side configuration

Low side configuration

High side configuration

Chopper

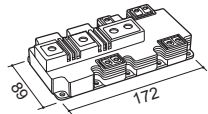

M271

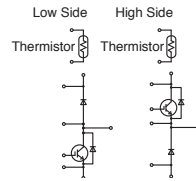

650A

900A

1000A

1400A

1MBI900VXA-120PD-50 *1	1MBI900VXA-120PC-50 *1
1MBI900VXA-120PD-54 *1	1MBI900VXA-120PC-54 *1

1MBI650VXA-170EL-50	1MBI650VXA-170EH-50
1MBI650VXA-170EL-54	1MBI650VXA-170EH-54

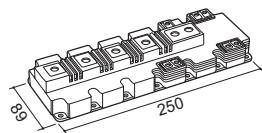

M272

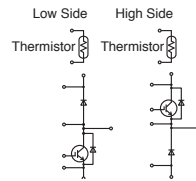

1MBI1400VXB-120PL-54	1MBI1400VXB-120PH-54
----------------------	----------------------

1MBI1000VXB-170EL-50	1MBI1000VXB-170EH-50
1MBI1000VXB-170EL-54	1MBI1000VXB-170EH-54

1MBI1400VXB-170PL-50	1MBI1400VXB-170PH-50
1MBI1400VXB-170PL-54	1MBI1400VXB-170PH-54

注 1 : -54 : V_{CE(sat)} 和 V_F 的等级会显示在标签中

注 2 : PrimePACK™ 为 Infineon Technologies 公司的注册商标。

*1 反向并联二极管的额定电流为 120A。仅用于 Boost/Buck chopper 电路。

T-type NPC 3-level Modules

外形尺寸 [mm]

	外形尺寸 [mm]	Ic	600V		1200V		1700V	
			V series	RB-IGBT	V series	RB-IGBT	V series	RB-IGBT
3 Phase With NTC, Solder pins M1203		50A			12MBI50VN-120-50	600V		
		75A			12MBI75VN-120-50	600V		
		100A			12MBI100VN-120-50	600V		
3 Phase With NTC, Press fit pins M1202		50A			12MBI50VX-120-50	600V		
		75A			12MBI75VX-120-50	600V		
		100A			12MBI100VX-120-50	600V		
1 Phase M403		220A					4MBI220VF-170R2-50	1200V
		300A			4MBI300VG-120R-50	600V		
					4MBI300VG-120R1-50	900V		
		340A			4MBI340VF-120R-50	600V		
		400A	4MBI400VG-060R-50	600V	4MBI400VF-120R-50	600V		
1 Phase M404		450A			4MBI450VB-120R1-50	900V	4MBI450VB-170R2-50	1200V
					4MBI450VB-120R1-60	900V	4MBI450VB-170R2-60	1200V
		600A					4MBI600VB-170R2-50	1200V
							4MBI600VB-170R2-60	1200V
		650A			4MBI650VB-120R1-50	900V		
					4MBI650VB-120R1-60	900V		
900A				4MBI900VB-120R1-50	900V			
				4MBI900VB-120R1-60	900V			
				4MBI900VB-120RA-50	600V			
				4MBI900VB-120RA-60	600V			

注 1 : -60 规格为印有特性数据的型号

注 2 : RB-IGBT 为反向阻断 (Reverse-Blocking) IGBT 的缩写, 是具备反向 (发射极与集电极间) 耐压的元件

I-type NPC 3-level Module

外形尺寸 [mm]

	外形尺寸 [mm]	Ic	600V	1200V	1700V
			V series	V series	V series
1 Phase M404		600A		4MBI600VC-120-50	
				4MBI600VC-120-60	

注 1 : -60 规格为印有特性数据的型号

Hybrid SiC Modules

外形尺寸 [mm]

Ic	1200V		1700V
	V series	VW series	V series
200A	2MSI200VAB-120-53		
200A		2MSI200VWAH-120-53	
300A	2MSI300VAH-120C-53	2MSI300VWAH-120-53	
400A			2MSI400VAE-170-53
300A	2MSI300VAN-120-53		
450A	2MSI450VAN-120-53		
600A	2MSI600VAN-120-53		

2-Pack

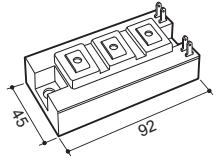

M274

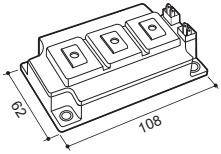
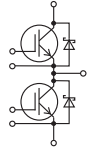

M276

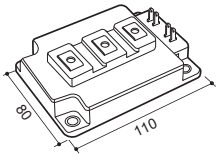
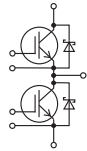

M277

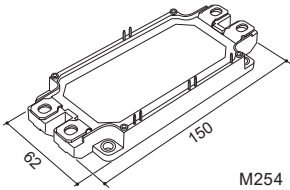
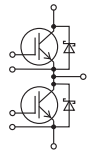

M254

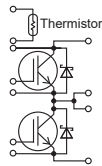



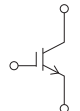









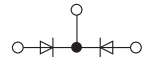
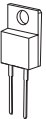
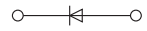
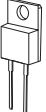

Discrete IGBT

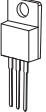
	Ic	600V		650V	1200V	
		V series	RB series	XS series	XS series	V series
TO-247 (Type:B)     RB-IGBT	30A			FGW30XS65		
	40A			FGW40XS65	FGW40XS120	
	50A			FGW50XS65		
	75A			FGW75XS65	FGW75XS120	
	15A					FGW15N120VD
	25A					FGW25N120VD
	30A	FGW30N60VD		FGW30XS65C		
	40A			FGW40XS65C	FGW40XS120C	FGW40N120VD
	50A	FGW50N60VD		FGW50XS65D		
				FGW50XS65C		
	75A			FGW75XS65D	FGW75XS120C	
				FGW75XS65C		
	85A		FGW85N60RB			
TO-247Plus-3  	100A				FGWP100XS120C *	
	140A				FGWP140XS120C *	
TO-247-4  	75A			FGZ75XS65C	FGZ75XS120C	
TO-247Plus-4H  	100A				FGZP100XS120C *	
	140A				FGZP140XS120C *	

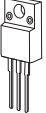
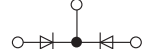
* 开发中

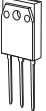
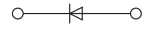
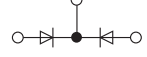
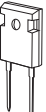
SiC Schottky Barrier Diodes (SiC-SBD)

SiC Schottky Barrier Diodes (SiC-SBD)	IF	650V		1200V	
		SiC-SBD 2G 	SiC-SBD 1G 	SiC-SBD 2G 	SiC-SBD 1G 
T-Pack(s) 	 	10A	FDCC10S65		
		20A			
		25A	FDCC25S65		
		20A	FDCC20C65		
TO-220-2 (Type:A) 		6A	FDC2PT06S65		
		8A	FDC2PT08S65		
		10A	FDC2PT10S65		
TO-220-2 (Type:B) 		10A	FDCP10S65		
		25A	FDCP25S65		
TO-220 		20A	FDCP20C65		
TO-220F 		20A	FDCA20C65		
TO-220F-2 		6A	FDC2AT06S65		
		8A	FDC2AT08S65		
		10A	FDC2AT10S65	FDCA10S65	
		18A			FDCA18S120
		25A		FDCA25S65	
TO-247 (Type:A) 	 	10A	FDCY10S65		
		18A			FDCY18S120
		25A	FDCY25S65		
		20A	FDCY20C65		
		36A			FDCY36C120
		50A	FDCY50C65		
TO-247-2 		18A			FDCW18T120
		20A		FDC2WT20S120	
		40A		FDC2WT40S120	

外形图 mm

M153

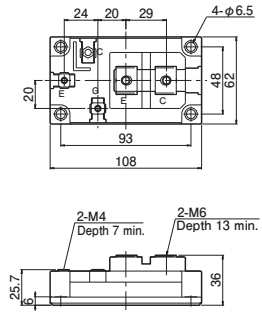

M254

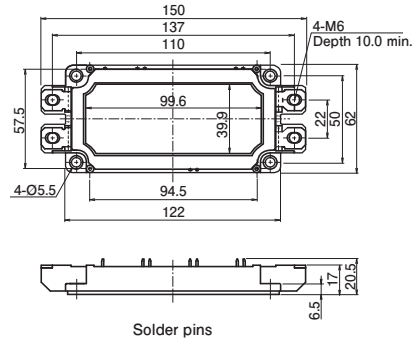

M262

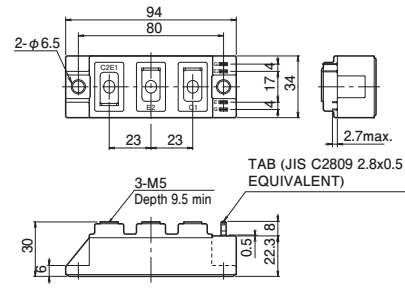

M263

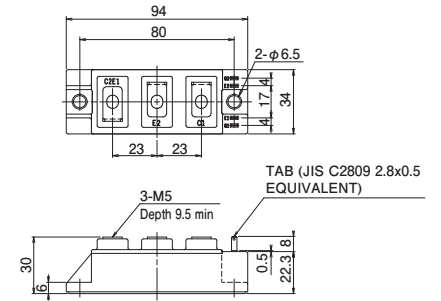

M271

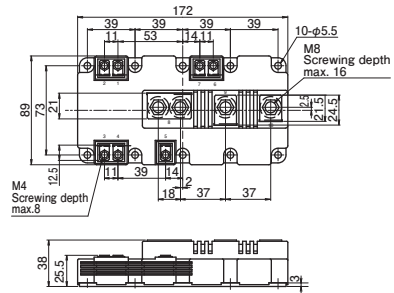

M272

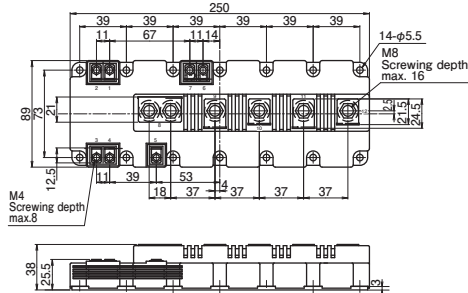

M274

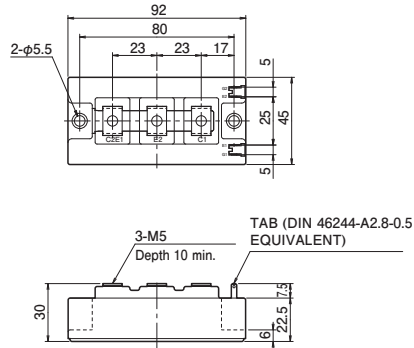

M275

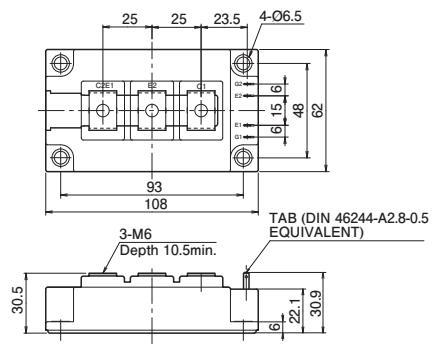

M276

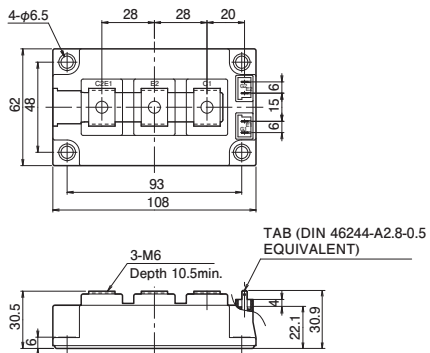

M277

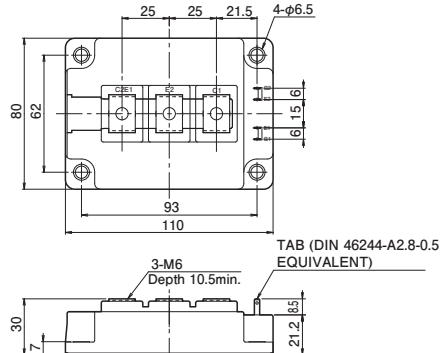

M282

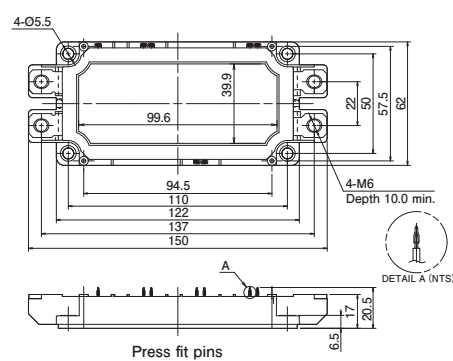

M283

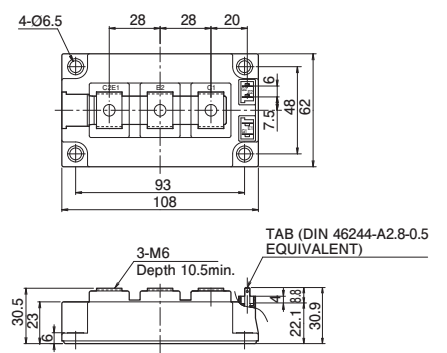

外形图 mm

M285

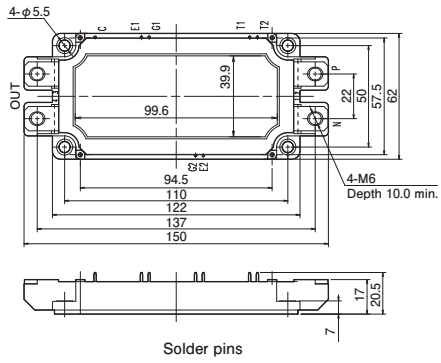

M286

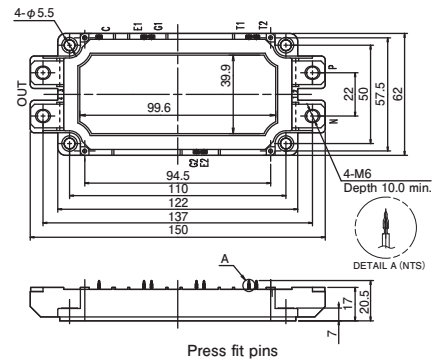

M291

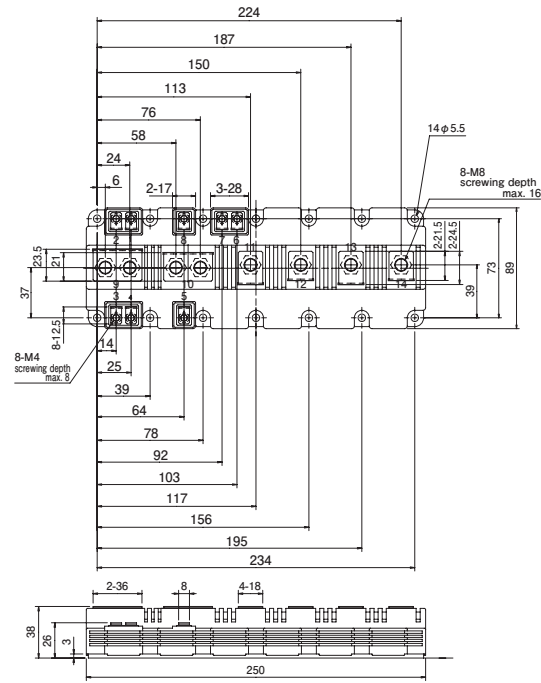

M297, M298

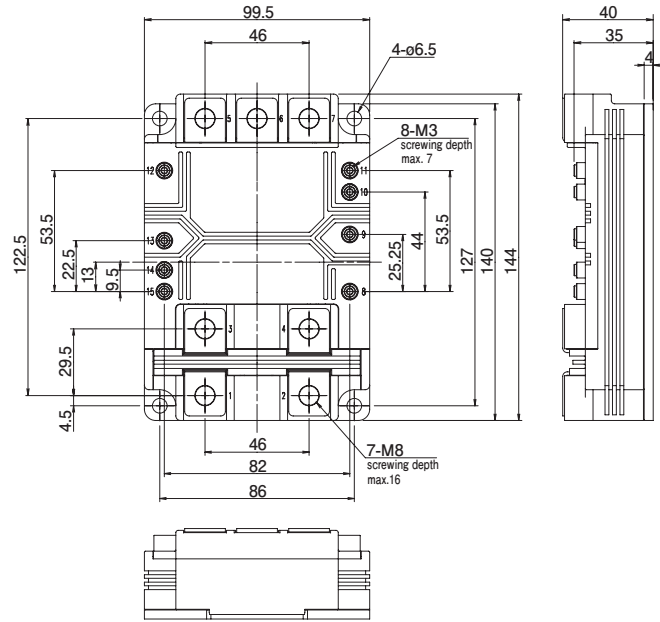

M295

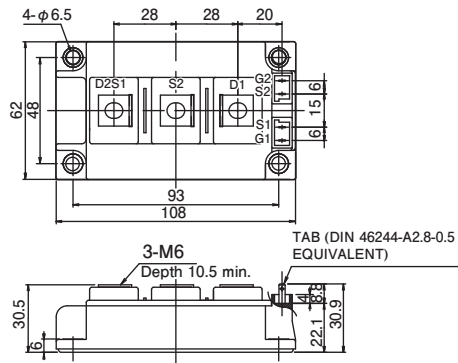

M403

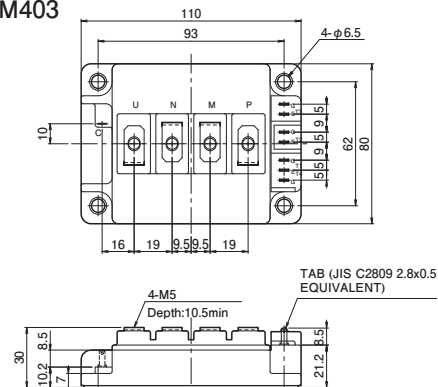

M404

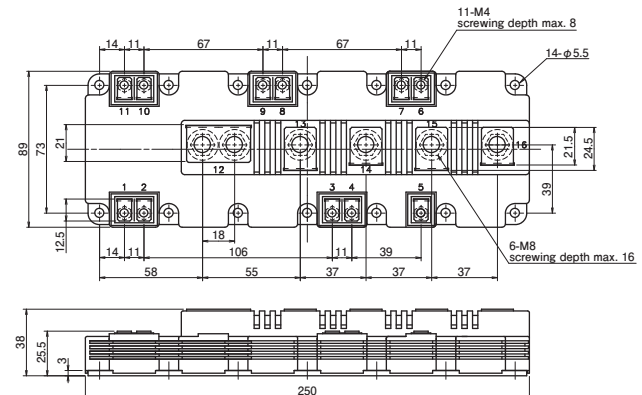

外形图 mm

M633

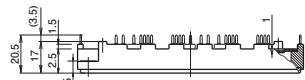
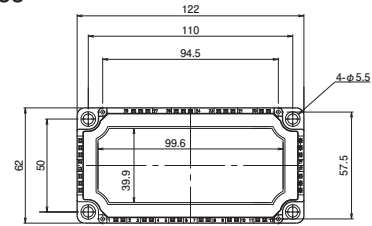

Solder pins

M636

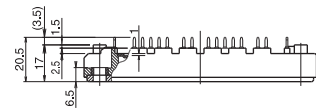
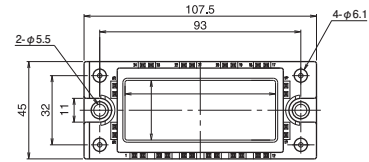

Solder pins

M647

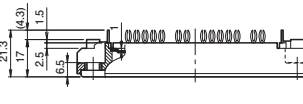
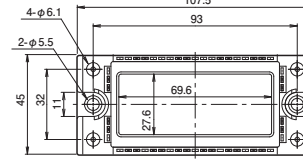

Press fit pins

M648

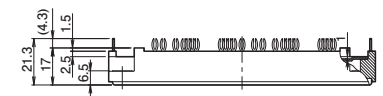
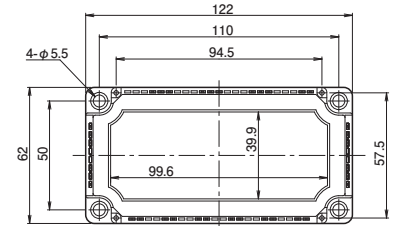

Press fit pins

M668

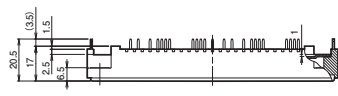
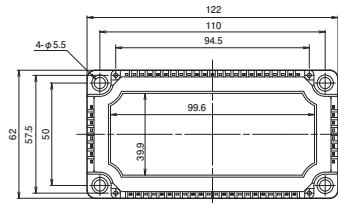

Solder pins

M669

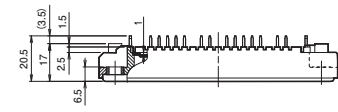
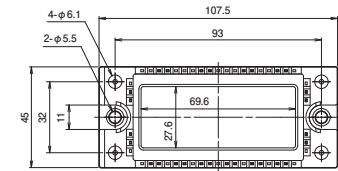

Solder pins

M711

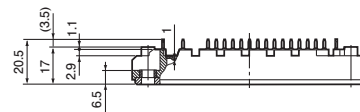
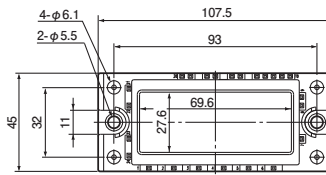

Solder pins

M712

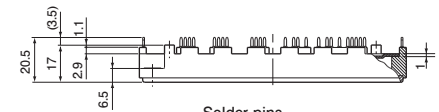
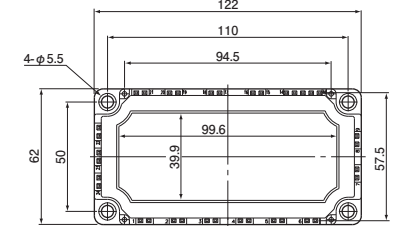

Solder pins

M719

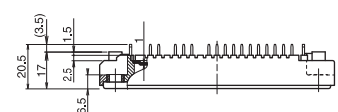
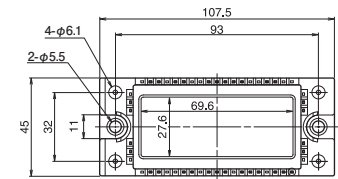

Solder pins

M720

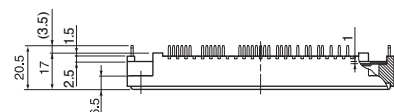
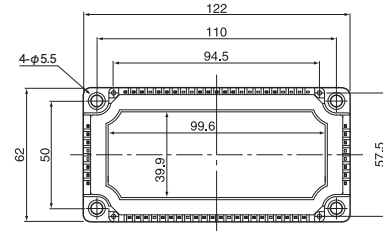

Solder pins

M721

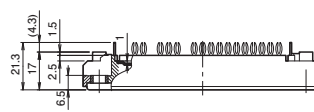
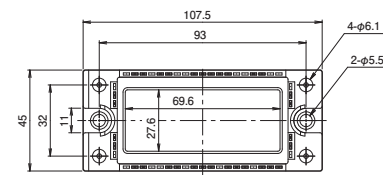

Press fit pins

M722

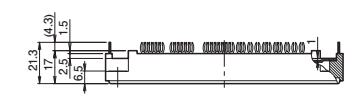
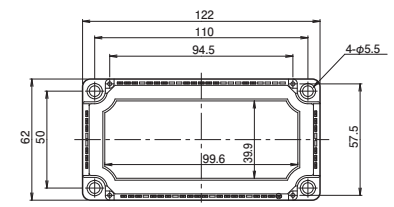

Press fit pins

外形图 mm

M726

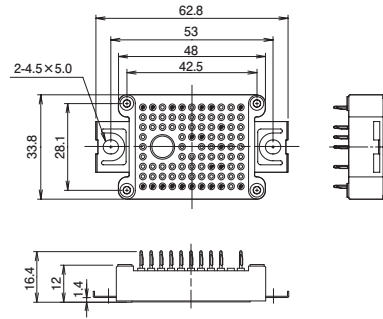

Press fit pins

M727

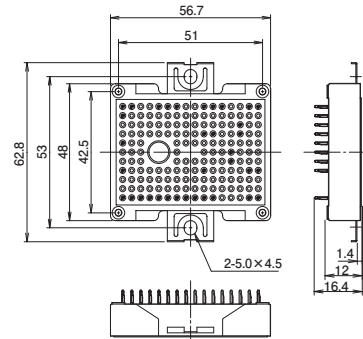

Press fit pins

M728

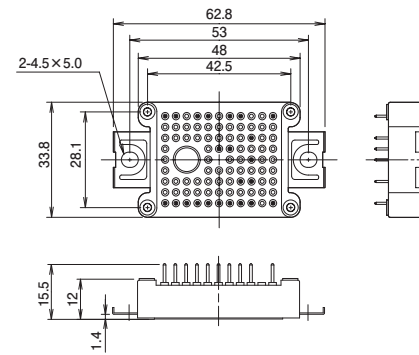

Solder pins

M729

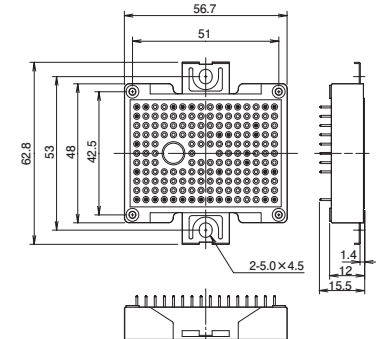

Solder pins

M730

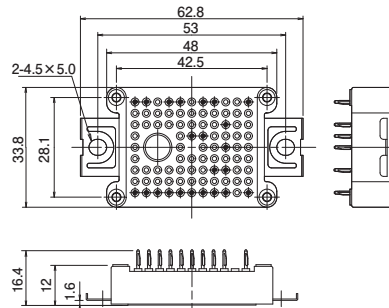

Press fit pins

M731

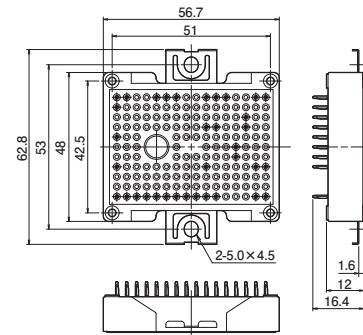

Press fit pins

M732

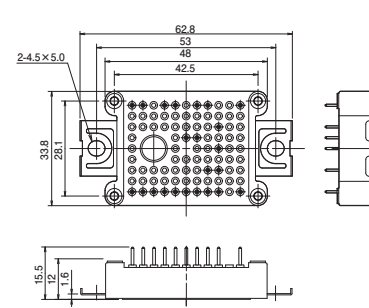

Solder pins

M733

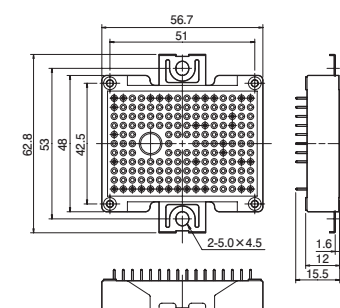

Solder pins

M1202

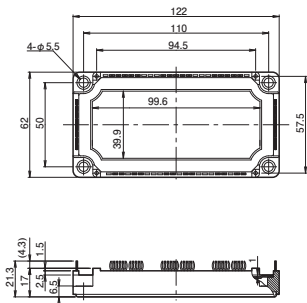

Press fit pins

M1203

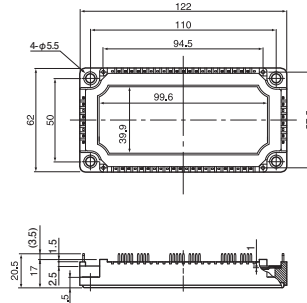

Solder pins

外形图 mm

P626

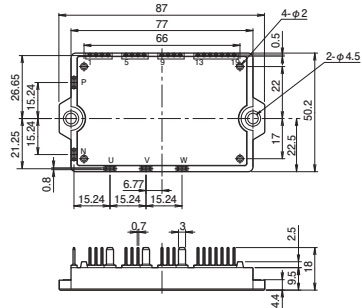

P629

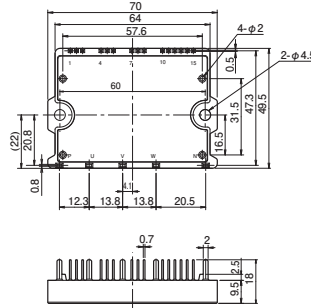

P630

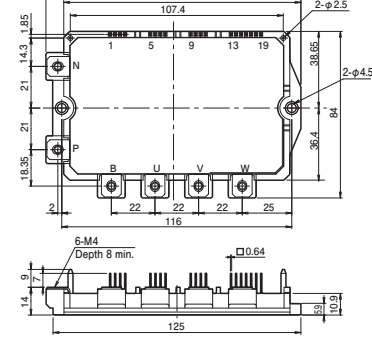

P631

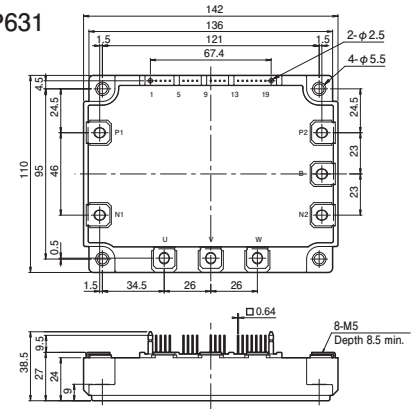

P633A

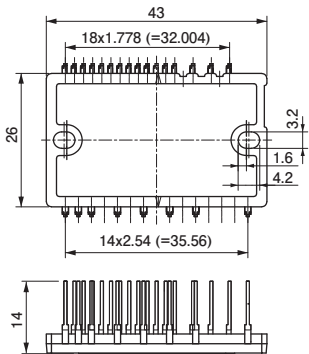

P633C

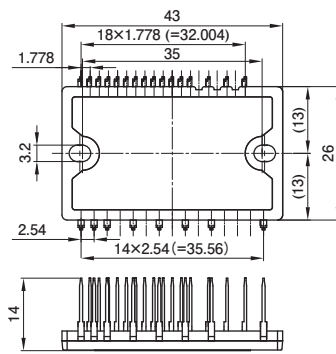

P636

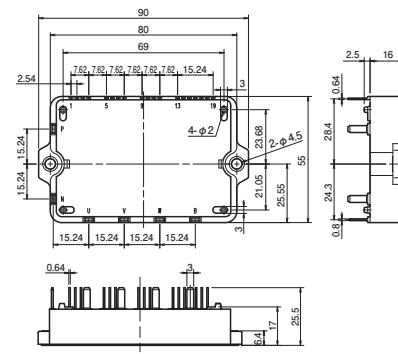

P638

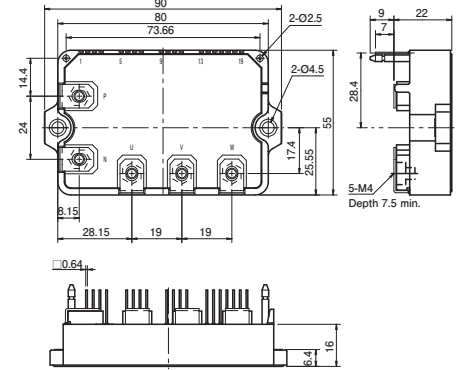

P639

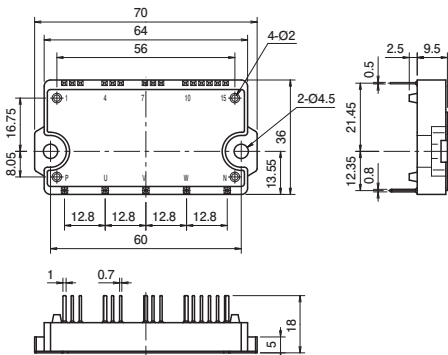

P641

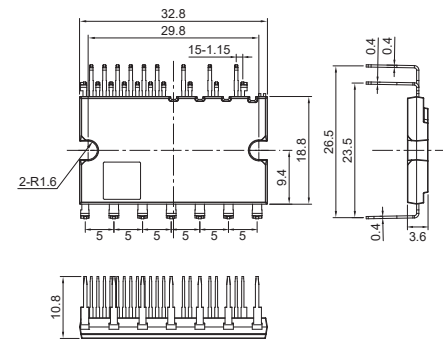

P642

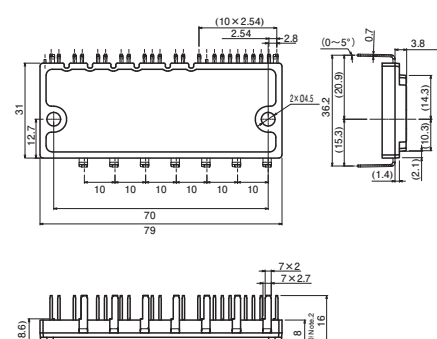

P644

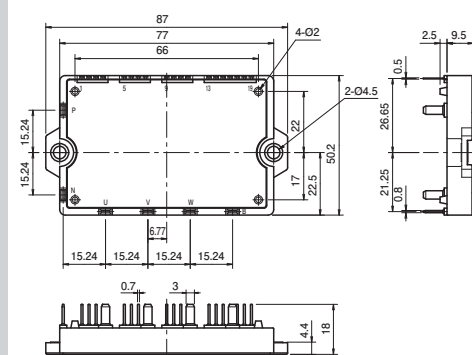

外形图 mm

TO-247 (Type:A)

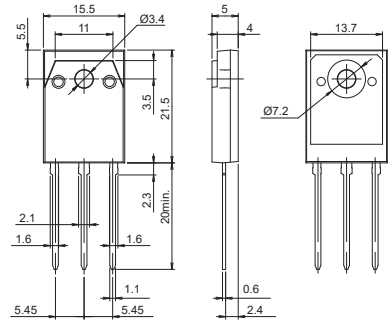

TO-247 (Type:B)

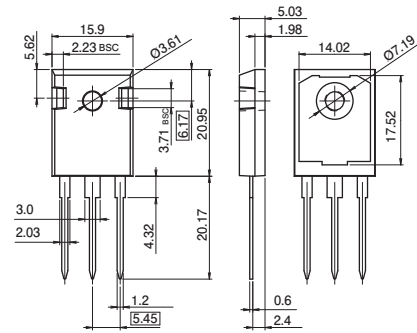

TO-247-2

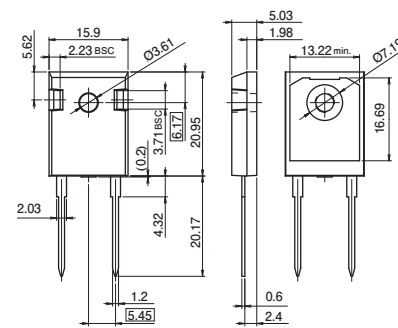

TO-247-4

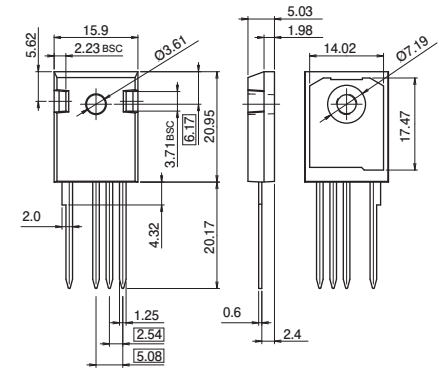

TO-220

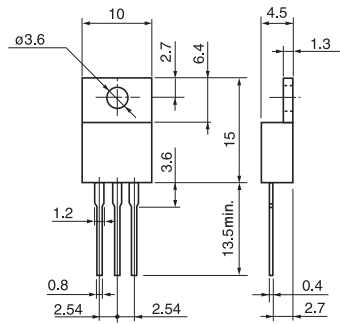

TO-220-2 (Type: A)

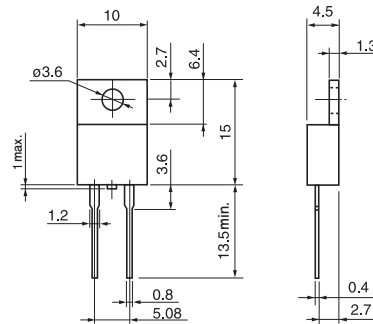

TO-220-2 (Type: B)

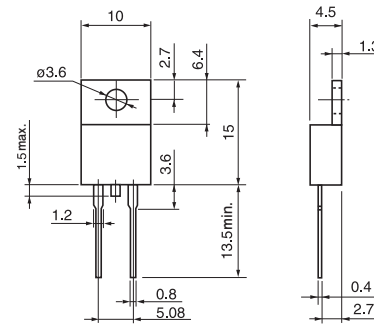

TO-220F

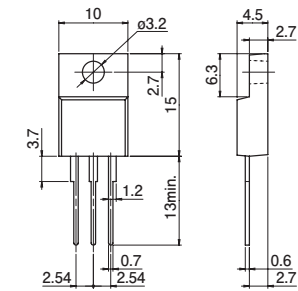

TO-220F-2

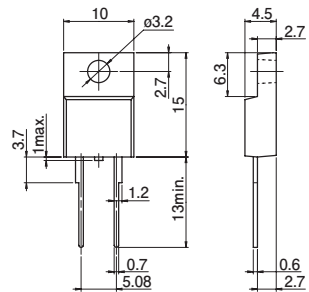

T-Pack(S)

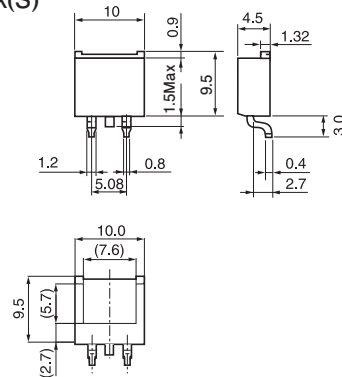

TO-247Plus-3

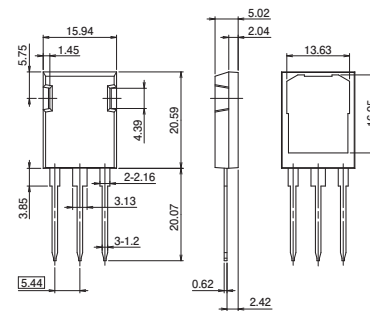

TO-247Plus-4H

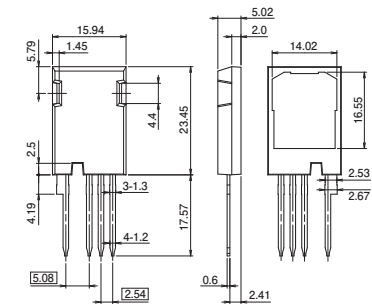

注意事项

1. 本产品目录的内容（产品的规格、特性、数据、材料、结构等）是截至 2025 年 3 月的内容。此内容可能会因产品的规格变更或者其他原因而随时变更，恕不另行通知。使用本产品目录中记载的产品时，请获取该产品的最新版规格书并确认数据。
2. 本产品目录中记载的应用示例是对使用富士电机株式会社半导体产品的代表性应用示例的说明，并非对工业所有权、其他权利的实施予以保证，或是承诺实施权。
3. 富士电机株式会社将不断努力提高产品的品质和可靠性。但是，半导体产品仍有可能发生故障。请采取冗余设计、防止火灾蔓延设计、防止误动作设计等确保安全的手段，防止因富士电机半导体产品故障而导致人身事故、引发火灾等造成财产损失或者造成社会性损失。
4. 本产品目录中记载的产品，以用于要求普通可靠性的以下电子设备和电气设备为目的制造而成。
 - 计算机
 - 办公设备
 - 通信设备（终端）
 - 测量设备
 - 机床
 - 视听设备
 - 家用电气产品
 - 个人设备
 - 工业机器人 等
5. 如您想要将本产品目录中记载的产品用于以下需要具有特别高可靠性的设备中，请事先与富士电机株式会社联系，并取得同意。如要将本产品目录中的产品用于这些设备，需要采取适当的措施确保安全，如备份系统等，这样即使安装在其中的富士电机半导体产品发生故障，设备也不会发生误动作。
 - 运输设备（车载、船舶用等）
 - 干线用通信设备
 - 交通信号设备
 - 煤气泄漏检测及断路器
 - 防灾 / 防盗装置
 - 用于确保安全的各种装置
6. 对于要求极高可靠性的以下设备以及属于战略物资的设备，请勿使用本产品目录中记载的产品。
 - 航天设备
 - 航空设备
 - 核能控制设备
 - 海底中转设备
7. 如要转载复制本产品目录的部分或全部内容，必须取得本公司的书面同意。
8. 关于此产品目录的内容，如有不明之处，请在使用产品前咨询富士电机株式会社或者其销售店。因未遵守本注意事项的指示而导致的任何损失，富士电机株式会社及其销售店概不负责。

安全相关注意事项

*使用前请仔细阅读“使用说明书”和“规格书”或咨询本公司或您购买产品的店铺,之后请正确使用。

*本产品应由具有本领域专业技能的人员进行使用和处理。

出口注意事项:

如果您希望出口该产品,请根据您所在国家的出口管制法律法规以及美国的再出口法规获取出口许可证或批准。

 富士电机株式会社

Power Semiconductors Group

www.fujielectric.com/products/semiconductor/cn/



Head Office:

Gate City Ohsaki, East Tower, 11-2 Osaki 1-chome,
Shinagawa-ku, Tokyo 141-0032, Japan

富士电机 (中国) 有限公司

上海市普陀区凯旋北路 1188 号环球港 B 座 26 楼

Tel: +86-21-5496-1177

富士電機 (香港) 有限公司

九龍旺角太子道西193號新世纪廣場第二座16字樓1601-1603 及05 室

Tel: +852-2664-8699

台灣富士電機股份有限公司

104486 台北市中山區松江路 168 號 5 樓

Tel: +886-2-2511-1820